

2022 —

PRODUCT CATALOG



A “FULL SERVICE” since 1965! —

Lourens van der Spruijt, our father and founder of Elvedes registered his own business with the Chamber of Commerce on February 8, 1965. He started with parts for mopeds, such as cables, sprockets, chains, pistons, buddy seats etc. Stock was kept under his bed and in his Opel Rekord. His first sale was one day later at a bike shop Staals in Utrecht.

For several years he visited bike shops directly to make sales. The demand for cables was remarkably high and it seemed this was something to put his focus on. Soon, Lourens started to assemble brake, throttle, clutch and speedometer cables for mopeds himself in his mother's kitchen. Elvedes changed from a moped parts trading company into a control cable business for mopeds and bicycles. Because there was no time left to

visit bike shops, he decided to work together with wholesale partners, who took care of the distribution for the Elvedes aftermarket cables. Besides aftermarket there was a large OEM market for brake and shift cables for bicycles.

In 2002 it was time for us, the next generation, to run the Elvedes business. We, his twin sons Carl and Peter, who were 24 years old at the time, started to find out where Elvedes was standing after 37 years, and where it had to go for the years to follow. We decided to put more focus on aftermarket and less on OEM products. Making the Elvedes brand bigger and stronger gives the company more certainty and continuity for the future. Besides cables, there were so many more service parts for bicycles which would be a perfect addition to expand the brand.



INDEX

First, we started to add rim and disc brake pads. Not only the most wanted, but also the exotic brake pads. If you want to be a “full service” aftermarket brand, you must add the full range and help your customer to find the right Elvedes product by providing “easy to find” product posters and “how to use” online videos. The market was enthusiastic, and from that point we started to extend the Elvedes WWproduct range step by step. Nowadays, there is a large assortment of Elvedes service parts for bicycles, which find their way all over Europe and further afield. All this success is achieved with a great team of Elvedes employees, our hard-core production partners and our professional distribution partners.

For the upcoming years, Elvedes will update and innovate their current product range, but will also expand with new product groups to highlight the “full service” brand that we are.

We believe that “full service” are the keywords to success. “Full service” to our Elvedes team, since our team is the most valuable part of our company. “Full service” to our production partners, because only together can we create the best products for the best price, and “full service” to our distribution partners, whose needs we are always trying to fill and make the Elvedes brand a significant asset for their businesses.

| | |
|-----------|------------------------------|
| 04 | BRAKE |
| 05 | DISC BRAKE SYSTEMS |
| 07 | CALIPER ADAPTERS |
| 08 | DISC BRAKE ROTORS |
| 11 | DISC BRAKE PARTS |
| 12 | DISC BRAKE PADS |
| 20 | RIM BRAKE PADS |
| 24 | CABLE |
| 25 | INNER CABLES |
| 28 | OUTER CABLES |
| 29 | ATB/RACE CABLES |
| 30 | CABLE KITS |
| 34 | CABLE PARTS |
| 40 | HYDRO |
| 41 | ORIGINAL BRANDS |
| 44 | HYDRO COMPONENTS |
| 46 | SHIMANO HYDRO COMPONENTS |
| 47 | O-RINGS |
| 48 | ROTATION |
| 49 | BEARINGS |
| 52 | HEADSET BEARINGS |
| 55 | HEADSET PARTS |
| 56 | PULLEY WHEELS |
| 58 | BOTTOM BRACKET GUIDE |
| 62 | BOTTOM BRACKETS |
| 64 | BOTTOM BRACKET PARTS |
| 66 | TOOLS AND MAINTENANCE |
| 67 | MAINTENANCE |
| 68 | CABLE TOOLS |
| 69 | MORE TOOLS |
| 70 | HYDRO TOOLS |
| 71 | BOTTOM BRACKET TOOLS |
| 72 | WORKSHOP |
| 73 | TRANSIT |
| 74 | BOXER |
| 75 | PARTNER |
| 76 | CADDY |
| 77 | PADFINDER |
| 78 | DISCOVERY |

BRAKE



MP1000 MECHANICAL DISC BRAKE CALIPER

2017130

Post mount
1 pce

Dual piston disc brake caliper



MP1000 MECHANICAL DISC BRAKE CALIPER

2019097

Flat mount
1 pce

Dual piston disc brake caliper



MP1000 MECHANICAL DISC BRAKE CALIPER

2019098

Post mount TWIN
1 pair left + right

Dual piston disc brake caliper



Left

Right

MECHANICAL DISC BRAKE LEVER

2,5 - 3 finger

| | | |
|---------|-------------------|--------|
| 2017131 | Left + right hand | 1 pair |
| 2018054 | Left hand | 1 pce |
| 2018055 | Right hand | 1 pce |



BRAKE

DISC BRAKE SYSTEMS

CALIPER ADAPTERS

DISC BRAKE ROTORS

DISC BRAKE PARTS

DISC BRAKE PADS

RIM BRAKE PADS

CABLE

INNER CABLES

OUTER CABLES

ATB/RACE CABLES

CABLE KITS

CABLE PARTS

HYDRO

ORIGINAL BRANDS

HYDRO
COMPONENTS

SHIMANO HYDRO
COMPONENTS

O-RINGS

ROTATION

BEARINGS

HEADSET BEARINGS

HEADSET PARTS

PULLEY WHEELS

BOTTOM BRACKET
GUIDE

BOTTOM BRACKETS

BOTTOM BRACKET
PARTS

TOOLS AND MAINTENANCE

MAINTENANCE

CABLE TOOLS

MORE TOOLS

HYDRO TOOLS

BOTTOM BRACKET
TOOLS

WORKSHOP

TRANSIT

BOXER

PARTNER

CADDY

PADFINDER

DISCOVERY

DISC BRAKE SYSTEMS

HP4000 HYDRAULIC DISC BRAKE SET

2017132

Mineral oil system
2.5 - 3 finger lever
Dual piston disc brake caliper

Replacement disc brake
pads for HP4000:
6890 model

Replacement
Ø160mm rotor: 2018053

Spare hose fitting set
for HP4000: CP2020139

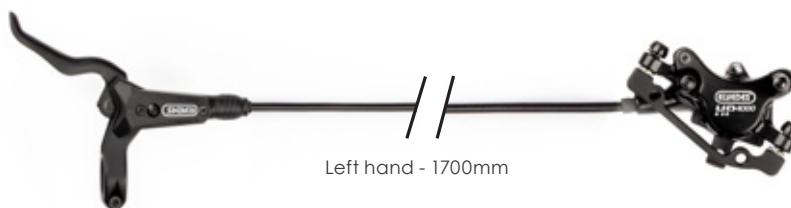

Left hand - 1700mm

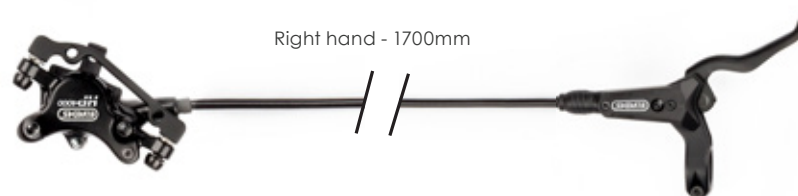

Right hand - 1700mm



HP4000 HYDRAULIC DISC BRAKE SET LEFT HAND

2018108

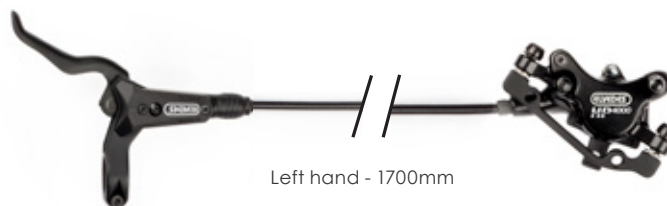

Left hand - 1700mm

HP4000 HYDRAULIC DISC BRAKE SET RIGHT HAND

2018107



Right hand - 1700mm

CALIPER ADAPTER

Adapter types are indicated caliper to frame
(e.g. PM-IS = PM caliper to IS frame/fork)
Bolts are included with every adapter



CP2017071

PM - IS

Ø160 front
Ø140 rear



CP2017072

PM - IS

Ø180 front
Ø160 rear



CP2015167

PM - IS

Ø180 rear



CP2015162

PM - IS

Ø203 front



CP2015168

PM - IS

Ø203 rear



CP2015158

PM - PM before 2013

Ø180



CP2016117

PM - PM after 2013

Ø140 → Ø160
Ø160 → Ø180



CP2015159

PM - PM

Ø160 → Ø203



CP2018058

PM - PM

Ø180 → Ø203



CP2019046

FM - PM

Ø140 front



CP2019047

FM - PM

Ø140 rear



CP2019048

FM - PM

Ø160 front



CP2019045

FM - PM

Ø160 rear



CP2019044

FM - FM

Ø140 front
Ø160 front



CP2017160

FM - FM

Ø160 rear



BRAKE

DISC BRAKE SYSTEMS

CALIPER ADAPTERS

DISC BRAKE ROTORS

DISC BRAKE PARTS

DISC BRAKE PADS

RIM BRAKE PADS

CABLE

INNER CABLES

OUTER CABLES

ATB/RACE CABLES

CABLE KITS

CABLE PARTS

HYDRO

ORIGINAL BRANDS

HYDRO COMPONENTS

SHIMANO HYDRO COMPONENTS

O-RINGS

ROTATION

BEARINGS

HEADSET BEARINGS

HEADSET PARTS

PULLEY WHEELS

BOTTOM BRACKET GUIDE

BOTTOM BRACKETS

BOTTOM BRACKET PARTS

TOOLS AND MAINTENANCE

MAINTENANCE

CABLE TOOLS

MORE TOOLS

HYDRO TOOLS

BOTTOM BRACKET TOOLS

WORKSHOP

TRANSIT

BOXER

PARTNER

CADDY

PADFINDER

DISCOVERY

DISC BRAKE ROTORS

SC ROTOR

Stainless steel with aluminium Centra-lock

| | | | |
|---------|------|---------|-------|
| 2020071 | SC14 | Ø140 mm | 130 g |
| 2020072 | SC16 | Ø160 mm | 154 g |
| 2020073 | SC18 | Ø180 mm | 180 g |
| 2020116 | SC20 | Ø203 mm | 230 g |

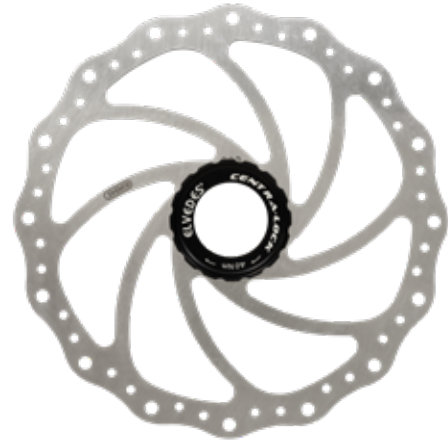

SX ROTOR

Stainless steel, 6 holes, including rotor bolts

| | | | |
|---------|------|---------|-------|
| 2014069 | SX14 | Ø140 mm | 86 g |
| 6820 | SX16 | Ø160 mm | 138 g |
| 6821 | SX18 | Ø180 mm | 151 g |
| 2017092 | SX20 | Ø203 mm | 188 g |



HP ROTOR

Stainless steel, 6 holes, including rotor bolts

| | | | |
|---------|------|---------|-------|
| 2018053 | HP16 | Ø160 mm | 96 g |
| 2019057 | HP18 | Ø180 mm | 127 g |



LX16 LIGHT WEIGHT ROTOR

Stainless steel, 6 holes, including rotor bolts

| | | | |
|---------|-----------|---------|------|
| 2015194 | Black | Ø160 mm | 85 g |
| 2015195 | Blue | Ø160 mm | 85 g |
| 2015196 | Red | Ø160 mm | 85 g |
| 2021066 | Stainless | Ø160 mm | 85 g |



LX18 LIGHT WEIGHT ROTOR

Stainless steel, 6 holes, including rotor bolts

| | | | |
|---------|-----------|---------|-------|
| 2015197 | Black | Ø180 mm | 112 g |
| 2015198 | Blue | Ø180 mm | 112 g |
| 2015199 | Red | Ø180 mm | 112 g |
| 2021067 | Stainless | Ø180 mm | 112 g |



BMX ROTOR

Stainless steel, 6 holes, including rotor bolts

| | |
|---------|---------|
| 2019055 | Ø120 mm |
|---------|---------|

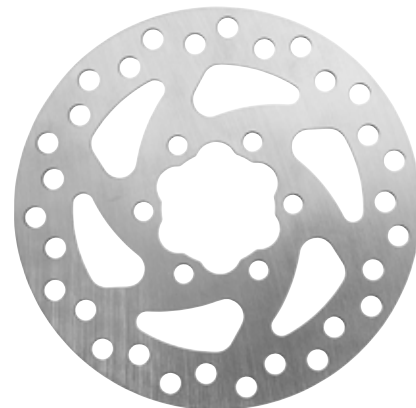

BRAKE

- DISC BRAKE SYSTEMS
- CALIPER ADAPTERS
- DISC BRAKE ROTORS
- DISC BRAKE PARTS
- DISC BRAKE PADS
- RIM BRAKE PADS

CABLE

- INNER CABLES
- OUTER CABLES
- ATB/RACE CABLES
- CABLE KITS
- CABLE PARTS

HYDRO

- ORIGINAL BRANDS
- HYDRO COMPONENTS
- SHIMANO HYDRO COMPONENTS
- O-RINGS

ROTATION

- BEARINGS
- HEADSET BEARINGS
- HEADSET PARTS
- PULLEY WHEELS
- BOTTOM BRACKET GUIDE
- BOTTOM BRACKETS
- BOTTOM BRACKET PARTS

TOOLS AND MAINTENANCE

- MAINTENANCE
- CABLE TOOLS
- MORE TOOLS
- HYDRO TOOLS
- BOTTOM BRACKET TOOLS

WORKSHOP

- TRANSIT
- BOXER
- PARTNER
- CADDY
- PADFINDER
- DISCOVERY

DISC BRAKE ROTORS

FX16 FLOATING ROTOR

Stainless steel and aluminium, 6 holes, including rotor bolts

| | | | |
|---------|-------|---------|-------|
| 2015146 | Black | Ø160 mm | 108 g |
| 2015147 | Blue | Ø160 mm | 108 g |
| 2015148 | Red | Ø160 mm | 108 g |



FX18 FLOATING ROTOR

Stainless steel and aluminium, 6 holes, including rotor bolts

| | | | |
|---------|-------|---------|-------|
| 2015149 | Black | Ø180 mm | 132 g |
| 2015150 | Blue | Ø180 mm | 132 g |
| 2015151 | Red | Ø180 mm | 132 g |



CRX COOLING ROTOR

Stainless steel and aluminium, 6 holes, including rotor bolts

| | | | |
|---------|-------|---------|-------|
| 2017162 | CRX14 | Ø140 mm | 101 g |
| 2017163 | CRX16 | Ø160 mm | 127 g |
| 2017164 | CRX18 | Ø180 mm | 152 g |



ROTOR ACCESSORIES

CP2012048

CNC Centra-lock
Adapter with lock ring
Aluminium
1 pce



2021068

CNC Centra-lock
Lock ring
Aluminium
1 pce



2019068

Rotor shim
0,1 mm
Stainless steel
8 pcs



2019054

Rotor shim
0,2 mm
Stainless steel
8 pcs



2017149

Rotor shim
1,0 mm
Stainless steel
1 pce



CP2015153

Rotor bolt
Torx head
Titanium CNC
6 pcs



2017187

Rotor bolt
Torx head
Stainless steel
12 pcs



ELV2015157

Rotor bolt
Torx head
Stainless steel
100 pcs



PINS AND CLIPS

2017178

Set screw
Magura Marta,
Gustava, Louise
2007
M4×22,5
10 pcs



2017179

Fixing pin
Shimano Deore,
Avid Elixir 1/3
35mm
30 pcs



2017180

Fixing pin
Hayes, Hope
45mm
10 pcs



2017181

Fixing bolt
Avid Elixir 5/7/9,
Guide, Code, Trail
M4×22
20 pcs



2017182

Fixing bolt
Shimano XT, XTR,
Magura MT 2/4/6/8,
Tektro, Formula Oro
M4×27
20 pcs



2017183

Fixing bolt
Hayes Ryde,
Dyno
M4×36
10 pcs



2017184

Fixing bolt
Formula Mega,
Hope E4/V4/
X2/V2
M5×25
10 pcs



2020247

Clip
M4/M5
10 pcs



2020248

Clip
SRAM
10 pcs



BRAKE

DISC BRAKE SYSTEMS
CALIPER ADAPTERS
DISC BRAKE ROTORS
DISC BRAKE PARTS
DISC BRAKE PADS
RIM BRAKE PADS

CABLE

INNER CABLES
OUTER CABLES
ATB/RACE CABLES
CABLE KITS
CABLE PARTS

HYDRO

ORIGINAL BRANDS
HYDRO
COMPONENTS
SHIMANO HYDRO
COMPONENTS
O-RINGS

ROTATION

BEARINGS
HEADSET BEARINGS
HEADSET PARTS
PULLEY WHEELS
BOTTOM BRACKET
GUIDE
BOTTOM BRACKETS
BOTTOM BRACKET
PARTS

TOOLS AND MAINTENANCE

MAINTENANCE
CABLE TOOLS
MORE TOOLS
HYDRO TOOLS
BOTTOM BRACKET
TOOLS

WORKSHOP

TRANSIT
BOXER
PARTNER
CADDY
PADFINDER
DISCOVERY

DISC BRAKE PAD GUIDE

HOW TO EXTEND THE LIFETIME OF YOUR DISC BRAKE PADS

Bed-in disc brake pads extend the life span of the pads considerably! Squeeze them in carefully and ensure that the pad just audibly touches the brake disc for approximately 100 metres at a speed of ± 25 km/hour. Now squeeze a little harder on the brake so that the speed decreases to approximately 5 km/hour, and then slowly increase the speed while gently squeezing the brake. Repeat this 10-12 times and the pads are worn in. Never brake to a stop with the brake still squeezed in order to prevent damage to the rotor. Always bed-in the front and rear brakes separately.

WHY ELVEDES DISC BRAKE PADS?

Elvedes believes that offering 3 different compounds can satisfy all riders in different circumstances with different bikes. Our compounds are compatible with all brands and types of stainless steel rotors on the market and will give you the brake power you will need. In the overview below, the performance of each compound is simply explained to easily make the right choice of disc brake pads.

ORGANIC (RESIN) COMPOUND

Excellent for gravel bikes, racing bikes and trekking bikes



METALLIC CARBON (SEMI-METAL) COMPOUND

Excellent for E-bikes, cargo bikes and delivery bikes

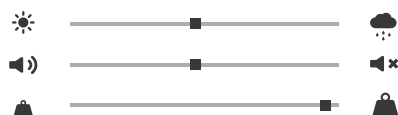

SINTERED (METAL) COMPOUND

Excellent for mountain bikes



ORDER QUANTITY

All organic, sintered and metallic carbon disc brake pads have a steel backplate.

XXXX -CARD

All disc brake pads can be ordered per card, containing 1 pair.

Necessary pins and clips included with all types of disc brake pads on card.



XXXX -BOX

Selected disc brake pads can be ordered per box, containing 10 pairs



XXXX -BOX25

Selected disc brake pads can be ordered per box, containing 25 pairs.



BRAKE

DISC BRAKE SYSTEMS

CALIPER ADAPTERS

DISC BRAKE ROTORS

DISC BRAKE PARTS

DISC BRAKE PADS

RIM BRAKE PADS

CABLE

INNER CABLES

OUTER CABLES

ATB/RACE CABLES

CABLE KITS

CABLE PARTS

HYDRO

ORIGINAL BRANDS

HYDRO COMPONENTS

SHIMANO HYDRO COMPONENTS

O-RINGS

ROTATION

BEARINGS

HEADSET BEARINGS

HEADSET PARTS

PULLEY WHEELS

BOTTOM BRACKET GUIDE

BOTTOM BRACKETS

BOTTOM BRACKET PARTS

TOOLS AND MAINTENANCE

MAINTENANCE

CABLE TOOLS

MORE TOOLS

HYDRO TOOLS

BOTTOM BRACKET TOOLS

WORKSHOP

TRANSIT

BOXER

PARTNER

CADDY

PADFINDER

DISCOVERY

BRAND _____

- | | | | | |
|--------------|-----------|------------|------------|------------|
| 1 Alhonga | 6 Clarks | 11 Grimeca | 16 Promax | 21 Suntour |
| 2 Assess | 7 Diatech | 12 Hayes | 17 Quad | 22 Tektro |
| 3 Avid | 8 Elvedes | 13 Hope | 18 RST | 23 TRP |
| 4 Campagnolo | 9 Formula | 14 Logan | 19 Shimano | 24 VanMoof |
| 5 Cannondale | 10 Giant | 15 Magura | 20 SRAM | 25 Zoom |

| NR | MODEL | ORGANIC | SINTERED | METALLIC CARBON |
|----|---|---------|----------|-----------------|
| 1 | SNG mechanical | 6872 | | 6872MC |
| 2 | C420, C425, C470 | 6886 | | 6886MC |
| | C430 | 6881 | | |
| 3 | BB3, BB5 | 6886 | | 6886MC |
| | BB7, Juicy | 6855 | 6855S | 6855MC |
| | Code, Code 5 | 6882 | | |
| | Code > 2011 | 6895 | 6895S | 6895MC |
| | DB1, DB3 | 6906 | 6906S | 6906MC |
| 4 | Elixir | 6890 | 6890S | 6890MC |
| | X0, X7, X9 Trail | 6898 | 6898S | 6898MC |
| 5 | Coda | 6908 | | |
| | Clout 1, S2 | 6865 | | |
| 6 | M1, M2, M3, CMD-22(FM), CMD-23, CMD-27 | 6854 | 6854S | 6854MC |
| | M4 | 6894 | 6894S | 6894MC |
| | Exo, Skeletal | 6891 | 6891S | 6891MC |
| | CMD-24, HDB-540, HDB-600, HDB-790 | 6860 | | |
| 7 | CMD-9, CMD-17(R) | 6859 | 6859S | |
| | CMD-15 | 6886 | | 6886MC |
| 8 | Anchor | 6855 | 6855S | 6855MC |
| | Twincam | 6880 | | |
| 9 | HP4000 | 6864 | | |
| | MP1000 | 6890 | 6890S | 6890MC |
| 10 | 4-Racing, B4 Team | 6894 | 6894S | 6894MC |
| | C1, Cura, Cura-E, Mega, R1 (R), RO(R), RX, The One | 6869 | | |
| | Cura 4 | 6893 | 6893S | 6893MC |
| | Extreme hydraulic | 6909 | 6909S | 6909MC |
| 11 | Oro | 6869 | | |
| | MPH 2000 | 6867 | | |
| 12 | MPH 2001 - 2003, MPH-2, MPH-3 | 6863 | 6863S | |
| | Root | 6852 | | |
| 13 | System 8, 12, 16 | 6861 | 6854S | 6854MC |
| | System 13 | 6853 | | |
| 14 | Dominion A4 | 6869 | | |
| | Dyno, Stroker Ryde | 6910 | 6910S | 6910MC |
| | El Camino | 6888 | 6888S | |
| | HFX, MX 1 | 6885 | | |
| 15 | Prime | 6850 | 6850S | |
| | Stroker Ace | 6896 | 6896S | |
| 16 | Stroker Carbon, Gram, Trail, GX2 | 6892 | | |
| | MX2, MX3, MX4, Sole | 6889 | 6889S | |
| 17 | C2, O2 | 6862 | | 6862MC |
| | DH4, M4 2002 | 6852 | | |
| 18 | E4, RX4-SH | 6871 | | |
| | Mini | 6903 | | |
| 19 | Mono 6 2007, 6-Ti 2004, Moto M6 | 6870 | | |
| | Mono M4 | 6876 | | |
| 20 | Mono Mini | 6853 | | |
| | Mono Trial, Trial Zone | 6877 | | |
| 21 | V2 | 6887 | | |
| | V4 | 6883 | | |
| 22 | X2 | 6899 | 6899S | |
| | XC4 | 6911 | 6911S | 6911MC |
| 23 | Clara 2000 - 2001, Louise 1999 - 2001 | 6873 | | |
| | Clara 2001 - 2002, Louise (FR) 2002 - 2006 | 6874 | | |
| 24 | Gustav M 2000 - 2011 | 6851 | | |
| | Julie 2001 - 2008 | 6857 | | |
| 25 | Julie HP, Louise > 2007, Louise Bat, Louise Carbon, Marta > 2009 | 6878 | | |
| | Marta 2002 - 2008, Marat SL 2003 - 2008 | 6856 | | |
| 26 | MT2, MT4, MT6, MT8, MT Sport | 6884 | 6884S | |
| | MT5, MT7 | 6860 | | |
| 27 | DC320, 610, 610J, 700, DSK400, 601J, Xnine | 6897 | 6897S | 6897MC |
| | DC600 | 6902 | 6902S | 6902MC |
| 28 | DC710, 720, 913, Decipher, DSK-300(R), 310, 330R, 715, Render (R) | 6904 | | |
| | DC901, 951 | 6879 | | |
| 29 | DC905, 907, 908, DSK-950 | 6850 | 6850S | |
| | DC910 | 6886 | | 6886MC |
| 30 | Decode R DSK-718R, DSK-909, E-Capsule, F1, Lucid, Solve | 6880 | | |
| | DSK-810 | 6855 | 6855S | 6855MC |
| 31 | Lucid P4 | 6851 | | |
| | QHD-1 | 6854 | 6854S | 6854MC |
| 32 | D-Power | 6854 | 6854S | 6854MC |
| | mechanical | 6866 | | |

| NR | MODEL | ORGANIC | SINTERED | METALLIC CARBON |
|----|--|---------|----------|-----------------|
| 1 | 105 BR-R7070, BR-RS505 | 6907 | 6907S | 6907MC |
| | Acera BR-M3060 | 6854 | 6854S | 6854MC |
| 2 | Alfine BR-S500, 501 | 6859 | 6859S | |
| | Alfine BR-S700 | 6894 | 6894S | 6894MC |
| 3 | Alivio BR-M395, 4050 | 6854 | 6854S | 6854MC |
| | Altus BR-M315, 365, 375 | 6854 | 6854S | 6854MC |
| 4 | BR-CX75, BR-R315, 517 | 6894 | 6894S | 6894MC |
| | BR-M355, 415, 416, 416A, 445, 447, 465, 475, 485, 486, 495, 575 | 6854 | 6854S | 6854MC |
| 5 | BR-M545, BR-R505, BR-T605 | 6859 | 6859S | |
| | BR-MT520 | 6891 | 6891S | 6891MC |
| 6 | BR-RS305 | 6907 | 6907S | 6907MC |
| | Deore BR-M515, 515LA, 525, BR-T 615 | 6854 | 6854S | 6854MC |
| 7 | Deore BR-M535, 595, 596 | 6859 | 6859S | |
| | Deore BR-M555, 555-M | 6858 | | |
| 8 | Deore BR-M615, BR-R785, BR-RS785 | 6894 | 6894S | 6894MC |
| | Deore LX BR-M585, BR-T665 | 6859 | 6859S | |
| 9 | Deore LX BR-TX805 | 6854 | 6854S | 6854MC |
| | Deore XT BR-M755, 755-DH | 6853 | | |
| 10 | Deore XT BR-M765, 775, 776 | 6859 | 6859S | |
| | Deore XT BR-M785, 8000 | 6894 | 6894S | 6894MC |
| 11 | Deore XT BR-M8020 | 6891 | 6891S | 6891MC |
| | Dura-ace BR-R9170 | 6907 | 6907S | 6907MC |
| 12 | Hone BR-M601 | 6859 | 6859S | |
| | Metrea BR-U5000 | 6907 | 6907S | 6907MC |
| 13 | Nexave BR-C501, 601 | 6854 | 6854S | 6854MC |
| | Nexave BR-C901 | 6858 | | |
| 14 | Saint BR-M800 | 6859 | 6859S | |
| | Saint BR-M810, 820 | 6891 | 6891S | 6891MC |
| 15 | SLX BR-M665 | 6859 | 6859S | |
| | SLX BR-M666, 675, 7000 | 6894 | 6894S | 6894MC |
| 16 | Sora BR-R317 | 6894 | 6894S | w6894MC |
| | Tiagra BR-RS405 | 6907 | 6907S | 6907MC |
| 17 | Tourney BR-C901 | 6854 | 6854S | 6854MC |
| | Ultegra BR-CX77 | 6894 | 6894S | 6894MC |
| 18 | Ultegra BR-R8070, BR-RS805 | 6907 | 6907S | 6907MC |
| | XTR BR-M9000, 9020, 985, 987 | 6894 | 6894S | 6894MC |
| 19 | XTR BR-M9120 | 6891 | 6891S | 6891MC |
| | XTR BR-M965, 966, 975 | 6859 | 6859S | |
| 20 | ZEE BR-M640 | 6891 | 6891S | 6891MC |
| | 700 B1 HRD, Apex, CX1, eTap, Force, HRR, Level TLM, Level Ultimate, Red, Rival, S900 | 6900 | 6900S | 6900MC |
| 21 | 9,0 | 6853 | | |
| | Code, Guide RE | 6895 | 6895S | 6895MC |
| 22 | DB5, Level, Level T, Level TL | 6906 | 6906S | 6906MC |
| | Guide R, Guide RS, Guide RSC, Guide Ultimate | 6898 | 6898S | 6898MC |
| 23 | Via GT, X0, XX, XX World Cup | 6890 | 6890S | 6890MC |
| | DB XCC-MC | 6875 | | |
| 24 | SR1 | 6879 | | |
| | Aquila MD-M500 | 6854 | 6854S | 6854MC |
| 25 | Aries MD-M300 | 6854 | 6854S | 6854MC |
| | Auriga E HD-E500, 520, 525, 530 | 6854 | 6854S | 6854MC |
| 26 | Auriga HD-E515, HD-T515, Auriga E HD-E510 | 6875 | | |
| | Auriga HD-M290, 291 HD-T520, 525, 530, Auriga Pro HD-M700 | 6854 | 6854S | 6854MC |
| 27 | Dorado 4P HD-E720, 725, HD-M745 | 6891 | 6891S | 6891MC |
| | Dorado HD-E710 | 6905 | | |
| 28 | Dorado HD-E715 | 6854 | 6854S | 6854MC |
| | Draco HD-M350, 351, 352 | 6854 | 6854S | 6854MC |
| 29 | Gemini HD-M500, 501, 510, 520, 521 | 6854 | 6854S | 6854MC |
| | HDC HD-M300, 301, 330 | 6854 | 6854S | 6854MC |
| 30 | HD-E350, HD-T285, MD-C510, MD-M280, MD-U510 | 6854 | 6854S | 6854MC |
| | HD-R310, 510 | 6907 | 6907S | 6907MC |
| 31 | IO | 6868 | | |
| | Junior HD-M282 | 6854 | 6854S | 6854MC |
| 32 | Lyra | 6901 | | |
| | Mira MD-C400 | 6854 | 6854S | 6854MC |
| 33 | Orion 4+2P (front) HD-M735, Orion 4P HD-M745 | 6891 | 6891S | 6891MC |
| | Orion HD-M720, 730, Orion 4+2P (rear) HD-M735, Orion SL HD-M740 | 6854 | 6854S | 6854MC |
| 34 | Vela HD-T290 | 6854 | 6854S | 6854MC |
| | Volans HD-T700 | 6875 | | |
| 35 | Volans HD-T710 | 6854 | 6854S | 6854MC |
| | Dash Sport, HY/RD, Hylex, Hylex RS | 6854 | 6854S | 6854MC |
| 36 | HD-C801, Parabox R, Slate X2, Spyke, Spyre | 6854 | 6854S | 6854MC |
| | G-Spec, Quadiem, Slate T4, Zurich | 6891 | 6891S | 6891MC |
| 37 | Hylex HD-C810, Hylex RS HD-C811, HD-T910 | 6907 | 6907S | 6907MC |
| | Model S | 6862 | | 6862MC |
| 38 | Model X | 6862 | | 6862MC |
| | | 6872 | | 6872MC |

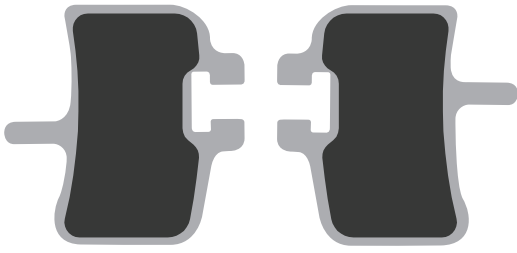

6850 - CARD
6850 S - CARD

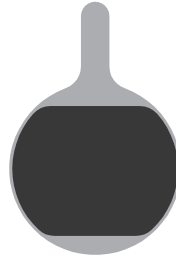

6851 - CARD



6852 - CARD

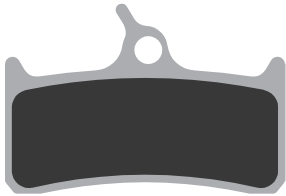

6853 - CARD

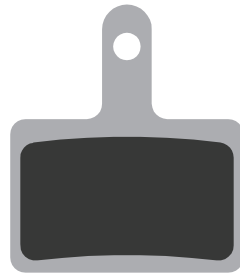

6854 - CARD / -BOX / -BOX25
6854 S - CARD / -BOX / -BOX25
6854 MC - CARD / -BOX / -BOX25

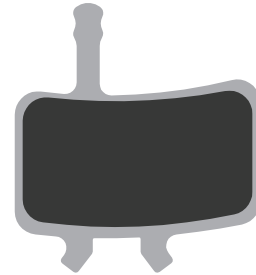

6855 - CARD
6855 S - CARD
6855 MC - CARD

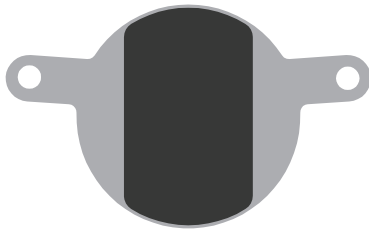

6856 - CARD



6857 - CARD

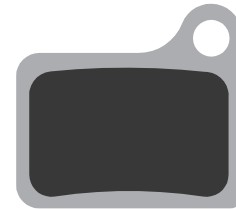

6858 - CARD



6859 - CARD
6859 S - CARD



6860 - CARD

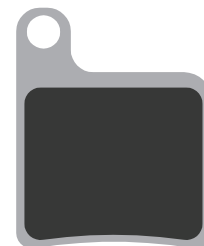

6861 - CARD

BRAKE

- DISC BRAKE SYSTEMS
- CALIPER ADAPTERS
- DISC BRAKE ROTORS
- DISC BRAKE PARTS
- DISC BRAKE PADS
- RIM BRAKE PADS

CABLE

- INNER CABLES
- OUTER CABLES
- ATB/RACE CABLES
- CABLE KITS
- CABLE PARTS

HYDRO

- ORIGINAL BRANDS
- HYDRO COMPONENTS
- SHIMANO HYDRO COMPONENTS
- O-RINGS

ROTATION

- BEARINGS
- HEADSET BEARINGS
- HEADSET PARTS
- PULLEY WHEELS
- BOTTOM BRACKET GUIDE
- BOTTOM BRACKETS
- BOTTOM BRACKET PARTS

TOOLS AND MAINTENANCE

- MAINTENANCE
- CABLE TOOLS
- MORE TOOLS
- HYDRO TOOLS
- BOTTOM BRACKET TOOLS

WORKSHOP

- TRANSIT
- BOXER
- PARTNER
- CADDY
- PADFINDER
- DISCOVERY

DISC BRAKE PADS



6862 - CARD
6862 MC - CARD

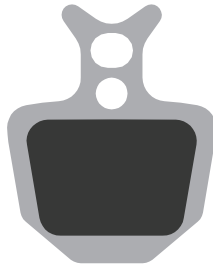

6863 - CARD
6863 S - CARD



6864 - CARD



6865 - CARD

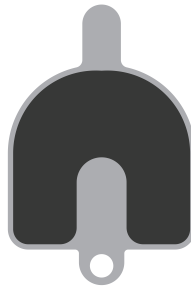

6866 - CARD



6867 - CARD

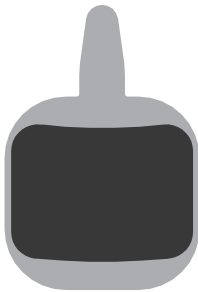

6868 - CARD



6869 - CARD

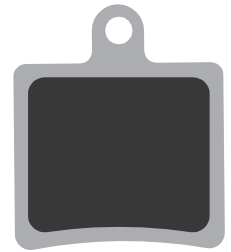

6870 - CARD

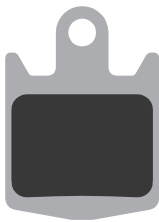

6871 - CARD



6872 - CARD
6872 MC - CARD

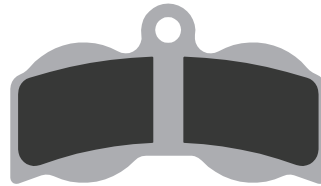

6873 - CARD



6874 - CARD

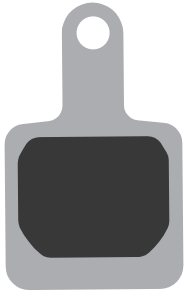

6875 - CARD

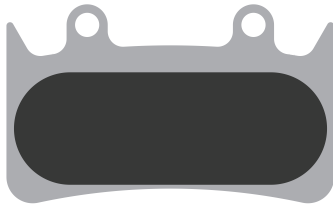

6876 - CARD

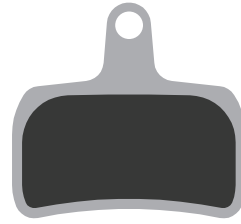

6877 - CARD



6878 - CARD



6879 - CARD

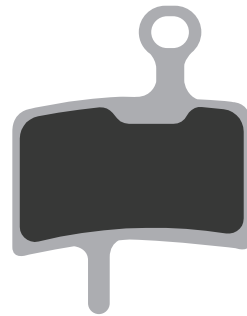

6880 - CARD

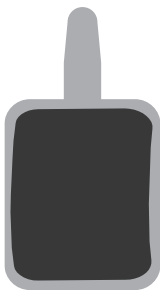

6881 - CARD

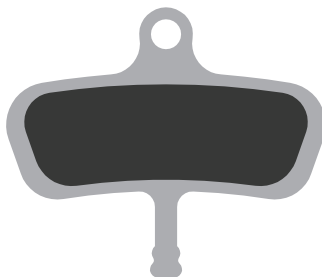

6882 - CARD

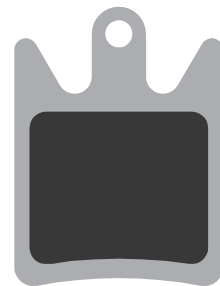

6883 - CARD

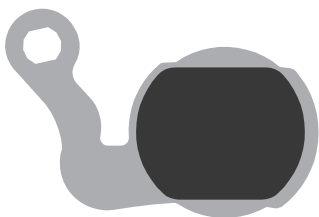

6884 - CARD
6884 S - CARD



6885 - CARD

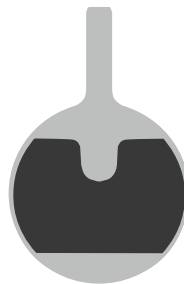

6886 - CARD
6886 MC - CARD

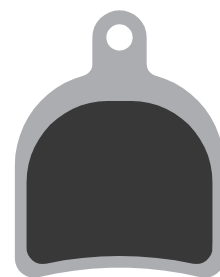

6887 - CARD

BRAKE

- DISC BRAKE SYSTEMS
- CALIPER ADAPTERS
- DISC BRAKE ROTORS
- DISC BRAKE PARTS
- DISC BRAKE PADS**
- RIM BRAKE PADS

CABLE

- INNER CABLES
- OUTER CABLES
- ATB/RACE CABLES
- CABLE KITS
- CABLE PARTS

HYDRO

- ORIGINAL BRANDS
- HYDRO COMPONENTS
- SHIMANO HYDRO COMPONENTS
- O-RINGS

ROTATION

- BEARINGS
- HEADSET BEARINGS
- HEADSET PARTS
- PULLEY WHEELS
- BOTTOM BRACKET GUIDE
- BOTTOM BRACKETS
- BOTTOM BRACKET PARTS

TOOLS AND MAINTENANCE

- MAINTENANCE
- CABLE TOOLS
- MORE TOOLS
- HYDRO TOOLS
- BOTTOM BRACKET TOOLS

WORKSHOP

- TRANSIT
- BOXER
- PARTNER
- CADDY
- PADFINDER
- DISCOVERY

DISC BRAKE PADS

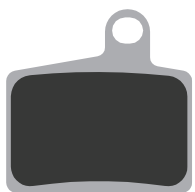

6888 - CARD
6888 S - CARD

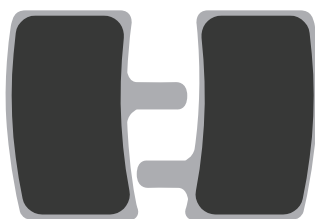

6889 - CARD
6889 S - CARD

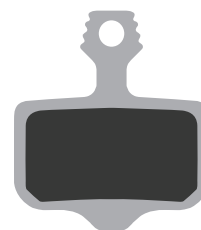

6890 - CARD / -BOX
6890 S - CARD / -BOX
6890 MC - CARD / -BOX



6891 - CARD
6891 S - CARD
6891 MC - CARD



6892 - CARD

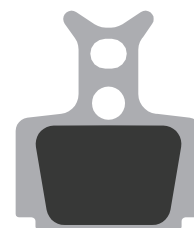

6893 - CARD
6893 S - CARD
6893 MC - CARD

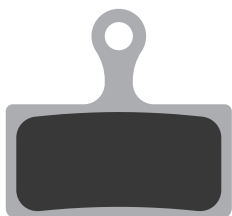

6894 - CARD / -BOX / -BOX25
6894 S - CARD / -BOX / -BOX25
6894 MC - CARD / -BOX / -BOX25

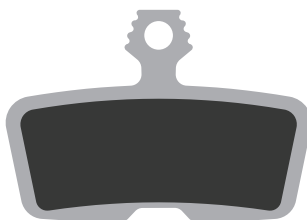

6895 - CARD
6895 S - CARD
6895 MC - CARD

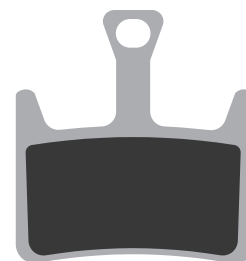

6896 - CARD
6896 S - CARD

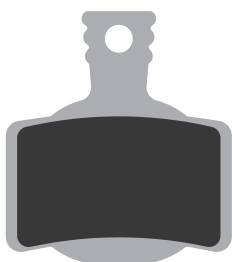

6897 - CARD / -BOX
6897 S - CARD / -BOX
6897 MC - CARD / -BOX



6898 - CARD / -BOX
6898 S - CARD / -BOX
6898 MC - CARD / -BOX

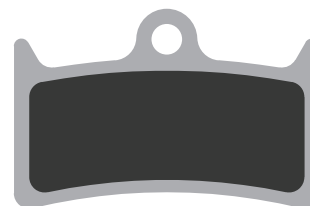

6899 - CARD
6899 S - CARD

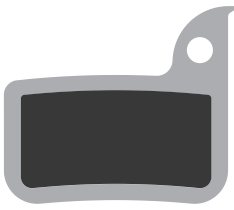

6900 - CARD / -BOX / -BOX25
 6900 S - CARD / -BOX / -BOX25
 6900 MC - CARD / -BOX / -BOX25

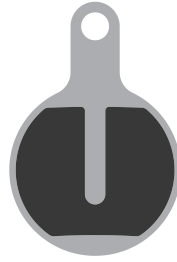

6901 - CARD

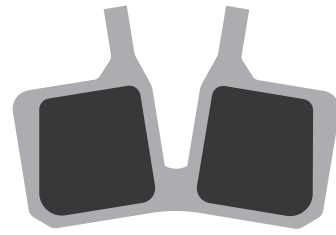

6902 - CARD / -BOX / -BOX25
 6902 S - CARD / -BOX / -BOX25
 6902 MC - CARD / -BOX / -BOX25

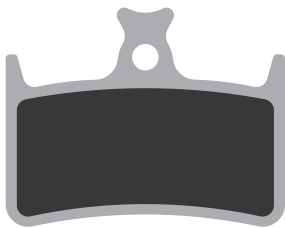

6903 - CARD



6904 - CARD

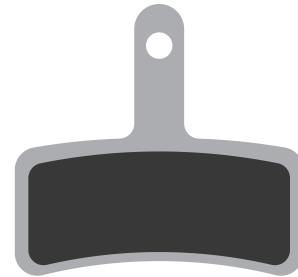

6905 - CARD

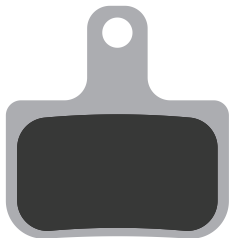

6906 - CARD / -BOX / -BOX25
 6906 S - CARD / -BOX / -BOX25
 6906 MC - CARD / -BOX / -BOX25

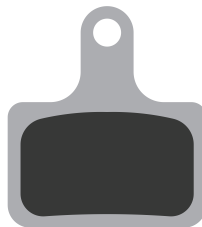

6907 - CARD / -BOX / -BOX25
 6907 S - CARD
 6907 MC - CARD

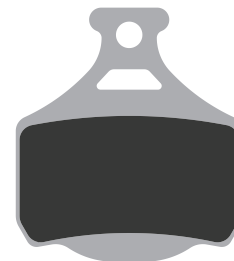

6908 - CARD

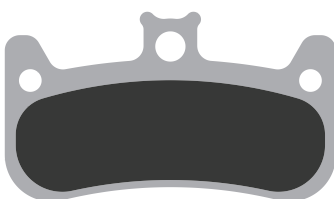

6909 - CARD
 6909 S - CARD
 6909 MC - CARD

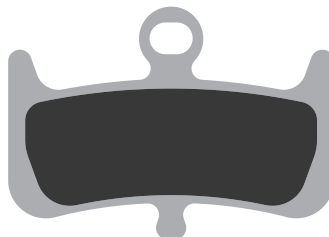

6910 - CARD
 6910 S - CARD
 6910 MC - CARD



6911 - CARD
 6911 S - CARD
 6911 MC - CARD

BRAKE

- DISC BRAKE SYSTEMS
- CALIPER ADAPTERS
- DISC BRAKE ROTORS
- DISC BRAKE PARTS
- DISC BRAKE PADS
- RIM BRAKE PADS

CABLE

- INNER CABLES
- OUTER CABLES
- ATB/RACE CABLES
- CABLE KITS
- CABLE PARTS

HYDRO

- ORIGINAL BRANDS
- HYDRO COMPONENTS
- SHIMANO HYDRO COMPONENTS
- O-RINGS

ROTATION

- BEARINGS
- HEADSET BEARINGS
- HEADSET PARTS
- PULLEY WHEELS
- BOTTOM BRACKET GUIDE
- BOTTOM BRACKETS
- BOTTOM BRACKET PARTS

TOOLS AND MAINTENANCE

- MAINTENANCE
- CABLE TOOLS
- MORE TOOLS
- HYDRO TOOLS
- BOTTOM BRACKET TOOLS

WORKSHOP

- TRANSIT
- BOXER
- PARTNER
- CADDY
- PADFINDER
- DISCOVERY

RIM BRAKE PAD GUIDE

☀️ BLACK COMPOUND

- For steel and aluminium rims
- Developed for dry conditions
- Excellent for city bike / trekking bike / racing bike



☁️ BLACK/RED COMPOUND

- For steel and aluminium rims
- Developed for wet conditions
- Excellent for MTB



☀️ ☁️ 📢 WHITE COMPOUND

- For steel and aluminium rims
- For more brake power
- Developed for dry and wet conditions
- Excellent for E-bike / racing bike / BMX



☀️ ☁️ BLUE COMPOUND

- For carbon rims only
- Developed for dry and wet conditions
- Excellent for racing bike / BMX



ORDER QUANTITY

XXXX -CARD

All rim brake pads can be ordered per card, containing 1 pair.

XXXX -BOX

Select rim brake pads can be ordered per box, containing 25 pairs.



6813

-CARD
Caliper
X-groove design



6843

-CARD
Caliper
X-groove design
More brake power
Less noise



6814

-CARD / -BOX
Power pads
compatible with
Magura HS11/33



6840

-CARD / -BOX
Power pads
compatible with
Magura HS11/33
More brake power
Less noise



6846

-CARD
Race
compatible with
Campagnolo
55 mm cartridge



6836

-CARD
Race
compatible with
Campagnolo
55 mm light weight cartridge
More brake power
Less noise



6844

-CARD
Race
compatible with
Campagnolo
55 mm light weight
cartridge
For carbon rims only



6822

-CARD
Race
compatible with
Campagnolo
55 mm replacement pad



6836, 6844, 6846

6838

-CARD
Race
compatible with
Campagnolo
55 mm replacement pad
More brake power
Less noise
6836, 6844, 6846



6826

-CARD
Race
compatible with
Campagnolo
55 mm replacement pad
For carbon rims only



6836, 6844, 6846

BRAKE

DISC BRAKE SYSTEMS
CALIPER ADAPTERS
DISC BRAKE ROTORS
DISC BRAKE PARTS
DISC BRAKE PADS
RIM BRAKE PADS

CABLE

INNER CABLES
OUTER CABLES
ATB/RACE CABLES
CABLE KITS
CABLE PARTS

HYDRO

ORIGINAL BRANDS
HYDRO COMPONENTS
SHIMANO HYDRO COMPONENTS
O-RINGS

ROTATION

BEARINGS
HEADSET BEARINGS
HEADSET PARTS
PULLEY WHEELS
BOTTOM BRACKET GUIDE
BOTTOM BRACKETS
BOTTOM BRACKET PARTS

TOOLS AND MAINTENANCE

MAINTENANCE
CABLE TOOLS
MORE TOOLS
HYDRO TOOLS
BOTTOM BRACKET TOOLS

WORKSHOP

TRANSIT
BOXER
PARTNER
CADDY
PADFINDER
DISCOVERY

RIM BRAKE PADS

6808

-CARD
Cantilever
70 mm symmetrical



6812

-BOX
Cantilever
72 mm



6833

-CARD
Cantilever
55 mm cartridge
Cyclocross



6834

-CARD
Cantilever
55 mm replacement pad
Cyclocross
6833



6842

-CARD / -BOX
Race
compatible with Shimano
55 mm



6848

-CARD
Race
compatible with Shimano
55 mm
More brake power
Less noise



6847

-CARD
Race
compatible with Shimano
55 mm



6835

-CARD
Race
compatible with Shimano
55 mm light weight cartridge
More brake power
Less noise



6845

-CARD
Race
compatible with Shimano
55 mm
For carbon rims only



6810

-CARD / -BOX
Race
compatible with Shimano
55 mm replacement pad



6835, 6845, 6847

6837

-CARD
Race
compatible with Shimano
55 mm replacement pad
More brake power
Less noise
6835, 6845, 6847



6827

-CARD
Race
compatible with Shimano
55 mm replacement pad
For carbon rims only
6835, 6845, 6847



6807

-CARD / -BOX
V-brake pads
55 mm replacement pad



6816

-CARD / -BOX
V-brake pads
70 mm symmetrical



6806

-CARD / -BOX
V-brake pads
72 mm



6828

-BOX
V-brake pads
72 mm
ABS design



6815

-CARD / -BOX
V-brake pads
72 mm
Special groove design



6832

-CARD / -BOX
V-brake pads
72 mm
More brake power
Less noise



6804

-CARD
V-brake pads
72 mm cartridge



6802

-CARD
V-brake pads
72 mm cartridge
Special groove design



6805

-CARD / -BOX
V-brake pads
72 mm replacement pad



6803

-CARD
V-brake pads
72 mm cartridge
Special groove design



6802, 6804

6802, 6804

6841

-CARD
V-brake pads
72 mm replacement pad
More brake power
Less noise
6802, 6804



6839

-CARD
V-brake pads
72 mm cartridge
For carbon rims only



6802, 6804

BRAKE

DISC BRAKE SYSTEMS
CALIPER ADAPTERS
DISC BRAKE ROTORS
DISC BRAKE PARTS
DISC BRAKE PADS
RIM BRAKE PADS

CABLE

INNER CABLES
OUTER CABLES
ATB/RACE CABLES
CABLE KITS
CABLE PARTS

HYDRO

ORIGINAL BRANDS
HYDRO COMPONENTS
SHIMANO HYDRO COMPONENTS
O-RINGS

ROTATION

BEARINGS
HEADSET BEARINGS
HEADSET PARTS
PULLEY WHEELS
BOTTOM BRACKET GUIDE
BOTTOM BRACKETS
BOTTOM BRACKET PARTS

TOOLS AND MAINTENANCE

MAINTENANCE
CABLE TOOLS
MORE TOOLS
HYDRO TOOLS
BOTTOM BRACKET TOOLS

WORKSHOP

TRANSIT
BOXER
PARTNER
CADDY
PADFINDER
DISCOVERY

CABLE



VOLUME BOX

All inner cables are compatible with Shimano, SRAM and Campagnolo

G - Galvanised
S - Stainless steel



19 strands Regular

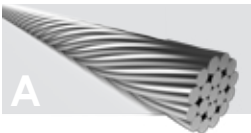

19 strands slick Extra smooth

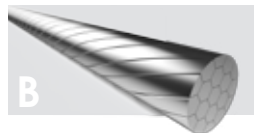

49 (7x7) strands Extra flexible

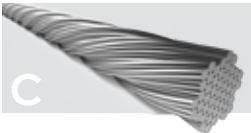

49 (7x7) strands slick Extra flexible, extra smooth



31 strands slick Medium flexible, extra smooth

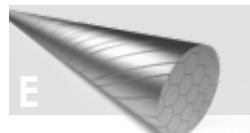

BRAKE

| | | | | |
|-------------------|---|----------|---|---------|
| 6426RVS-BOX | S | 2 000 mm | A | 100 pcs |
| 6426RVS-SLICK-BOX | S | 2 000 mm | B | 100 pcs |
| 6427RVS-BOX | S | 2 250 mm | A | 100 pcs |
| 6427RVS-SLICK-BOX | S | 2 250 mm | B | 100 pcs |
| 6427RVS-49-BOX | S | 2 250 mm | C | 100 pcs |
| 6427RVS-3M-BOX | S | 3 000 mm | A | 50 pcs |

BRAKE

| | | | | |
|-------------------|---|----------|---|---------|
| 6411RVS-BOX | S | 2 000 mm | A | 100 pcs |
| 6411RVS-SLICK-BOX | S | 2 000 mm | B | 100 pcs |
| 6411RVS-49-BOX | S | 2 000 mm | C | 100 pcs |

SHIFT

| | | | | |
|----------------------|---|----------|---|---------|
| 6472RVS-BOX | S | 2 250 mm | A | 100 pcs |
| 6472RVS-SLICK-BOX | S | 2 250 mm | B | 100 pcs |
| 6472RVS-49-BOX | S | 2 250 mm | C | 100 pcs |
| 6472RVS-49-SLICK-BOX | S | 2 250 mm | D | 50 pcs |
| 6472RVS-3M-BOX | S | 3 000 mm | A | 50 pcs |

SHIFT

Only compatible with Shimano and SRAM

| | | | | |
|----------------------|---|----------|---|---------|
| 6472RVS-SHIM-BOX | S | 2 250 mm | A | 100 pcs |
| 6472RVS-SHIM-SL-BOX | S | 2 250 mm | B | 100 pcs |
| 6472RVS-SH-49-SL-BOX | S | 2 250 mm | D | 50 pcs |
| 2021056-BOX | S | 2 250 mm | E | 50 pcs |

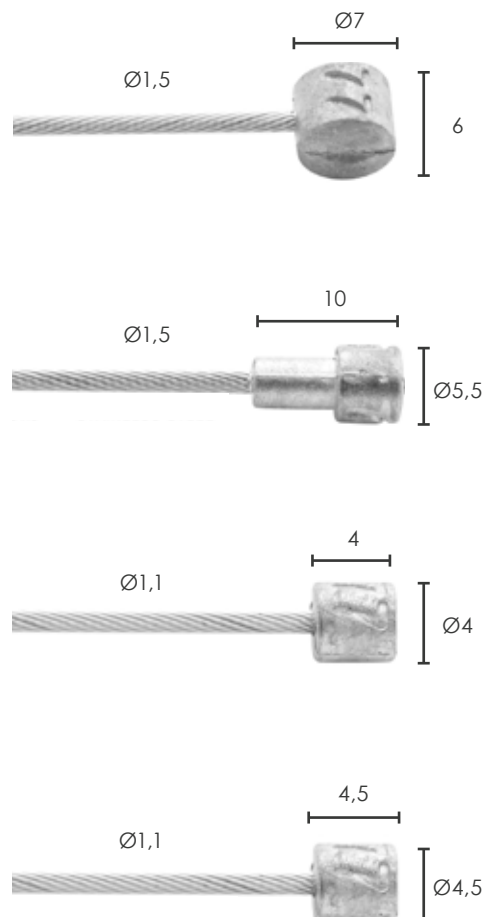

BRAKE

DISC BRAKE SYSTEMS
CALIPER ADAPTERS
DISC BRAKE ROTORS
DISC BRAKE PARTS
DISC BRAKE PADS
RIM BRAKE PADS

CABLE

INNER CABLES
OUTER CABLES
ATB/RACE CABLES
CABLE KITS
CABLE PARTS

HYDRO

ORIGINAL BRANDS
HYDRO COMPONENTS
SHIMANO HYDRO COMPONENTS
O-RINGS

ROTATION

BEARINGS
HEADSET BEARINGS
HEADSET PARTS
PULLEY WHEELS
BOTTOM BRACKET GUIDE
BOTTOM BRACKETS
BOTTOM BRACKET PARTS

TOOLS AND MAINTENANCE

MAINTENANCE
CABLE TOOLS
MORE TOOLS
HYDRO TOOLS
BOTTOM BRACKET TOOLS

WORKSHOP

TRANSIT
BOXER
PARTNER
CADDY
PADFINDER
DISCOVERY

INNER CABLES

CARD

All inner cables are compatible with Shimano, SRAM and Campagnolo

Types of inner cables

- G** - Galvanised
- S** - Stainless steel



19 strands Regular

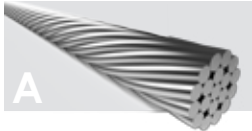

19 strands slick Extra smooth

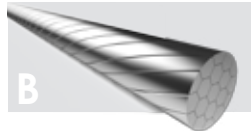

49 (7x7) strands Extra flexible

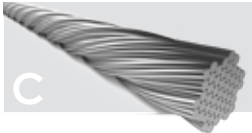

49 (7x7) strands slick Extra flexible, extra smooth



31 strands slick Medium flexible, extra smooth

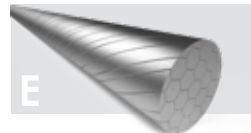

BRAKE

| | | | | |
|---------------|---|----------|---|--------|
| 6414 | G | 900 mm | A | 20 pcs |
| 6414RVS | S | 1 000 mm | A | 20 pcs |
| 6416 | G | 1 250 mm | A | 20 pcs |
| 6416RVS | S | 1 250 mm | A | 20 pcs |
| 6426 | G | 2 000 mm | A | 20 pcs |
| 6426RVS | S | 2 000 mm | A | 20 pcs |
| 6426RVS-SLICK | S | 2 000 mm | B | 20 pcs |
| 6427 | G | 2 250 mm | A | 20 pcs |
| 6427RVS | S | 2 250 mm | A | 20 pcs |
| 6427RVS-SLICK | S | 2 250 mm | B | 20 pcs |
| 6427RVS-49 | S | 2 250 mm | C | 20 pcs |
| 6427-3M | G | 3 000 mm | A | 15 pcs |
| 6427RVS-3M | S | 3 000 mm | A | 15 pcs |
| 6427RVS-5M | S | 5 000 mm | A | 10 pcs |

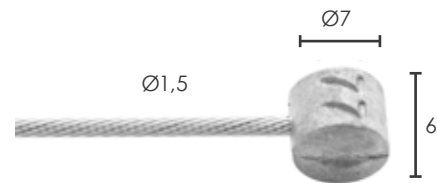

BRAKE

| | | | | |
|------------------|---|----------|---|--------|
| 6412/27 | G | 2 250 mm | A | 20 pcs |
| 6412/27RVS | S | 2 350 mm | A | 20 pcs |
| 6412/27RVS-SLICK | S | 2 350 mm | B | 20 pcs |
| 6412/27RVS-49 | S | 2 250 mm | C | 20 pcs |
| 6412/27RVS-3M | S | 3 000 mm | A | 15 pcs |
| 6412/27-4M | G | 4 000 mm | A | 10 pcs |
| 6412/27RVS-4M | S | 4 000 mm | A | 10 pcs |

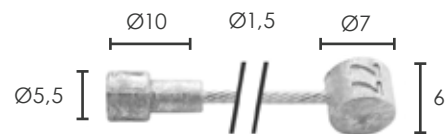

BRAKE

| | | | | |
|---------------|---|----------|---|--------|
| 6411 | G | 2 000 mm | A | 20 pcs |
| 6411RVS | S | 2 000 mm | A | 20 pcs |
| 6411RVS-SLICK | S | 2 000 mm | B | 20 pcs |
| 6412 | G | 2 250 mm | A | 20 pcs |
| 6412RVS | S | 2 250 mm | A | 20 pcs |
| 6412RVS-SLICK | S | 2 250 mm | B | 20 pcs |
| 6412-49 | G | 2 250 mm | C | 20 pcs |
| 6412RVS-49 | S | 2 250 mm | C | 20 pcs |

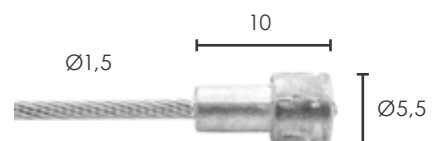

SHIFT

Only compatible with Shimano and SRAM

| | | | | |
|--------------------|---|----------|---|---------------|
| 6472RVS-SHIM | S | 2 250 mm | A | 20 pcs/carton |
| 6472RVS-SHIM-SLICK | S | 2 250 mm | B | 20 pcs/carton |
| 6472RVS-SHIM-49-SL | S | 2 250 mm | D | 20 pcs/carton |
| 2020213 | S | 4 000 mm | D | 15 pcs/carton |
| 2021056 | S | 2 250 mm | E | 20 pcs/carton |
| 2021057 | S | 4 000 mm | E | 15 pcs/carton |

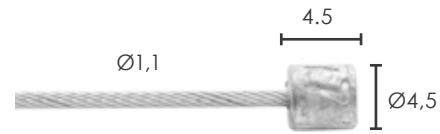

SHIFT

| | | | | |
|---------|---|----------|---|---------------|
| 6446 | G | 2 250 mm | A | 20 pcs/carton |
| 6446RVS | S | 2 250 mm | A | 20 pcs/carton |

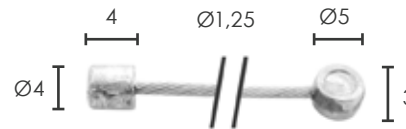

SHIFT

| | | | | |
|------------|---|----------|---|---------------|
| 6400 | G | 2 250 mm | A | 20 pcs/carton |
| 6400RVS | S | 2 250 mm | A | 20 pcs/carton |
| 6400RVS-3M | S | 3 000 mm | A | 15 pcs/carton |

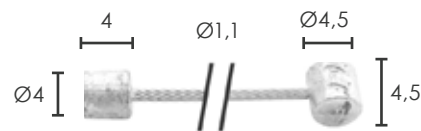

SHIFT

| | | | | |
|------------------|---|----------|---|---------------|
| 6446-1 | G | 2 250 mm | A | 20 pcs/carton |
| 6472RVS | S | 2 250 mm | A | 20 pcs/carton |
| 6472RVS-SLICK | S | 2 250 mm | B | 20 pcs/carton |
| 6472RVS-3M | S | 3 000 mm | A | 20 pcs/carton |
| 6472RVS-49 | S | 2 250 mm | C | 20 pcs/carton |
| 6472RVS-49-SLICK | S | 2 250 mm | D | 20 pcs/carton |
| 6472RVS-4M | S | 4 000 mm | A | 15 pcs/carton |
| 6472RVS-5M | S | 5 000 mm | A | 15 pcs/carton |



SHIFT

| | | | | |
|---------------|---|----------|---|---------------|
| 6451/72RVS | S | 2 250 mm | A | 20 pcs/carton |
| 6451/72RVS-3M | S | 3 000 mm | A | 20 pcs/carton |

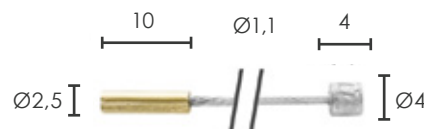

SHIFT

| | | | | |
|---------|---|----------|---|---------------|
| 6451/18 | G | 2 250 mm | A | 20 pcs/carton |
|---------|---|----------|---|---------------|

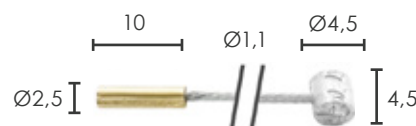

BRAKE

- DISC BRAKE SYSTEMS
- CALIPER ADAPTERS
- DISC BRAKE ROTORS
- DISC BRAKE PARTS
- DISC BRAKE PADS
- RIM BRAKE PADS

CABLE

- INNER CABLES
- OUTER CABLES
- ATB/RACE CABLES
- CABLE KITS
- CABLE PARTS

HYDRO

- ORIGINAL BRANDS
- HYDRO COMPONENTS
- SHIMANO HYDRO COMPONENTS
- O-RINGS

ROTATION

- BEARINGS
- HEADSET BEARINGS
- HEADSET PARTS
- PULLEY WHEELS
- BOTTOM BRACKET GUIDE
- BOTTOM BRACKETS
- BOTTOM BRACKET PARTS

TOOLS AND MAINTENANCE

- MAINTENANCE
- CABLE TOOLS
- MORE TOOLS
- HYDRO TOOLS
- BOTTOM BRACKET TOOLS

WORKSHOP

- TRANSIT
- BOXER
- PARTNER
- CADDY
- PADFINDER
- DISCOVERY

OUTER CABLES

VOLUME BOX

All Elvedes outer cables have MoS₂ enriched liner for lower friction and higher performance.

The outer cable volume boxes come with an easy pull reel made of 100% recycled and 100% recyclable plastic.

The boxes are also equipped with a unique GripClip, which prevents the outer cable from slipping back into the box after cutting.



The cable type is indicated by the letter A, B, C or D

Brake cable



Braided brake cable



Shift cable



Braided shift / brake cable



SHIFT Ø4,1

| Box 30m | Bag 10m | Colour |
|---------------|--------------|----------------|
| 1120SP-1-BOX | 1120SP-1-10 | C Black |
| 1120SP-3-BOX | 1120SP-3-10 | C Silver |
| 1120SP-6-BOX | 1120SP-6-10 | C White |
| 1120SP-7-BOX | 1120SP-7-10 | C Red |
| 1120SP-8-BOX | 1120SP-8-10 | C Blue |
| 1120SP-9-BOX | 1120SP-9-10 | C Orange |
| 1120SP-10-BOX | 1120SP-10-10 | C Green |
| 1120SP-11-BOX | 1120SP-11-10 | C Neon orange |
| 1120SP-12-BOX | 1120SP-12-10 | C Neon yellow |
| 1120SP-13-BOX | 1120SP-13-10 | C Neon green |
| 1120SP-14-BOX | 1120SP-14-10 | C Yellow |
| 1120SP-15-BOX | 1120SP-15-10 | C Pink |
| 2019089-BOX | 2019089-10 | C Brown |
| 2019091-BOX | 2019091-10 | C Celeste |

SHIFT Ø4,9

| Box 30m | Bag 10m | Colour |
|--------------|-------------|-----------------|
| 1125SP-1-BOX | 1125SP-1-10 | C Black |
| 1125SP-3-BOX | 1125SP-3-10 | C Silver |
| 182041-BOX | 182041-10 | D Silver |
| 182042-BOX | 182042-10 | D Smoke silver |
| 182043-BOX | 182043-10 | D Titanium |

BRAKE AND SHIFT Ø4,9

| Box 30m | Bag 10m | Colour |
|-------------|------------|-----------|
| 2010016-BOX | 2010016-10 | D Carbon |
| 2020256-BOX | 2020256-10 | D Black |

BRAKE Ø4,9

| Box 30m | Bag 10m | Colour |
|----------------|---------------|-----------------|
| 1125-BOX | 1125-10 | - Black |
| 1125TEF-1-BOX | 1125TEF-1-10 | A Black |
| 1125TEF-2-BOX | 1125TEF-2-10 | A Grey |
| 1125TEF-3-BOX | 1125TEF-3-10 | A Silver |
| 1125TEF-6-BOX | 1125TEF-6-10 | A White |
| 1125TEF-7-BOX | 1125TEF-7-10 | A Red |
| 1125TEF-8-BOX | 1125TEF-8-10 | A Blue |
| 1125TEF-9-BOX | 1125TEF-9-10 | A Orange |
| 1125TEF-10-BOX | 1125TEF-10-10 | A Green |
| 1125TEF-11-BOX | 1125TEF-11-10 | A Neon orange |
| 1125TEF-12-BOX | 1125TEF-12-10 | A Neon yellow |
| 1125TEF-13-BOX | 1125TEF-13-10 | A Neon green |
| 1125TEF-14-BOX | 1125TEF-14-10 | A Yellow |
| 1125TEF-15-BOX | 1125TEF-15-10 | A Pink |
| 2019088-BOX | 2019088-10 | A Brown |
| 2019090-BOX | 2019090-10 | A Celeste |
| 1125LSR-6-BOX | 1125LSR-6-10 | A Black/chrome |
| 1125LSR-7-BOX | 1125LSR-7-10 | A Chrome |
| 182038-BOX | 182038-10 | B Silver |
| 182039-BOX | 182039-10 | B Smoke silver |
| 182040-BOX | 182040-10 | B Titanium |

Linear outer cable for powerful braking and precise shifting. Excellent for cargo bikes, tandems and mechanical disc brakes.

CABLE KIT

All cable kits fit Shimano, Campagnolo and SRAM

19 strands regular



49 (7x7) strands slick Extra flexible, extra smooth

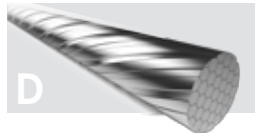

BRAKE

- DISC BRAKE SYSTEMS
- CALIPER ADAPTERS
- DISC BRAKE ROTORS
- DISC BRAKE PARTS
- DISC BRAKE PADS
- RIM BRAKE PADS

CABLE

- INNER CABLES
- OUTER CABLES
- ATB/RACE CABLES
- CABLE KITS
- CABLE PARTS

BRAKE CABLE KIT

fits MTB and road systems

| | | | |
|---------|---|--------|--|
| 2015009 | A | Black | |
| 2015010 | A | Silver | |
| 2015011 | A | White | |
| 2015012 | A | Red | |
| 2015013 | A | Blue | |
| 2015014 | A | Orange | |
| 2015015 | A | Green | |
| 2017150 | A | Pink | |
| 2017152 | A | Yellow | |

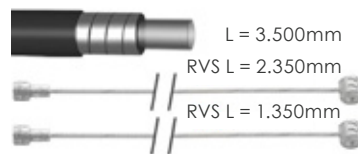

HYDRO

- ORIGINAL BRANDS
- HYDRO COMPONENTS
- SHIMANO HYDRO COMPONENTS
- O-RINGS

SHIFT CABLE KIT

fits MTB and road systems

| | | | |
|---------|---|--------|--|
| 2015002 | A | Black | |
| 2015003 | A | Silver | |
| 2015004 | A | White | |
| 2015005 | A | Red | |
| 2015006 | A | Blue | |
| 2015007 | A | Orange | |
| 2015008 | A | Green | |
| 2017151 | A | Pink | |
| 2017153 | A | Yellow | |

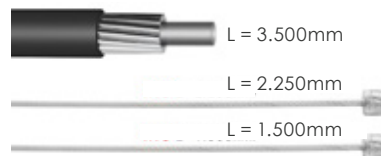

ROTATION

- BEARINGS
- HEADSET BEARINGS
- HEADSET PARTS
- PULLEY WHEELS
- BOTTOM BRACKET GUIDE
- BOTTOM BRACKETS
- BOTTOM BRACKET PARTS

1X SHIFT CABLE KIT

| | | | |
|---------|---|-------|--|
| 2021040 | D | Black | |
|---------|---|-------|--|

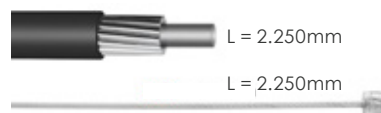

TOOLS AND MAINTENANCE

- MAINTENANCE
- CABLE TOOLS
- MORE TOOLS
- HYDRO TOOLS
- BOTTOM BRACKET TOOLS

SHIFT OT-RS900

| | | | |
|---------|--------|-------|----------------------------|
| 2021073 | 240 mm | Black | 1 pce/bag, 15 bags/carton |
| 2021074 | 240 mm | Black | 10 pcs/bag, 15 bags/carton |



WORKSHOP

- TRANSIT
- BOXER
- PARTNER
- CADDY
- PADFINDER
- DISCOVERY

CABLE KITS

CARD

All cable kits are available per card.
Cards per carton are mentioned per item no.

Types of inner cables

G - Galvanised

S - Stainless steel



BRAKE

2021071 1 800 mm Black 15 pcs/carton



SHIFT

2021072 2 000 mm Black 15 pcs/carton



DRUMBRAKE

6473 G 2 250 mm 14 pcs/carton

6473RVS S 2 350 mm 14 pcs/carton



DRUMBRAKE

6269SP G 1 800 mm 2 250 mm Black 15 pcs/carton

6269SP-RVS S 1 800 mm 2 350 mm Black 15 pcs/carton

6269SP-3 S 1 800 mm 2 350 mm Silver 15 pcs/carton



DRUMBRAKE

6268SP G 1 100 mm 1 250 mm Black 15 pcs/carton

6268SP-RVS S 1 100 mm 1 350 mm Black 15 pcs/carton

6268SP-3 S 1 100 mm 1 350 mm Silver 15 pcs/carton

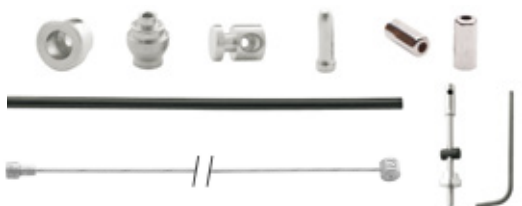

BRAKE UNIVERSAL

6445 G 1 800 mm 2 250 mm Black 15 pcs/carton

6445RVS S 1 800 mm 2 350 mm Black 15 pcs/carton

6445-3 S 1 800 mm 2 350 mm Silver 15 pcs/carton



BRAKE 2 NIPPLES

6444/39 G 1 800 mm 2 250 mm Black 15 pcs/carton

6444/39-RVS S 1 800 mm 2 350 mm Black 15 pcs/carton



BRAKE

6439 G 1 800 mm 2 000 mm Black 15 pcs/carton

BRAKE

6436 G 540 mm 900 mm Black 15 pcs/carton
 6436RVS S 540 mm 900 mm Black 15 pcs/carton
 6444 G 1 800 mm 2 000 mm Black 15 pcs/carton
 6444RVS S 1 800 mm 2 000 mm Black 15 pcs/carton

ROLLERBRAKE BR-IM45/55/80/81/85

2012025 S 1 100 mm 1 250 mm Black 15 pcs/carton
 2012026 S 1 100 mm 1 250 mm Silver 15 pcs/carton
 2012027 S 1 800 mm 2 250 mm Black 15 pcs/carton
 2012028 S 1 800 mm 2 250 mm Silver 15 pcs/carton

ROLLERBRAKE BR-IM41/50/53

6282 S 1 100 mm 1 250 mm Black 15 pcs/carton
 6283 S 1 800 mm 2 250 mm Black 15 pcs/carton
 6284 S 1 100 mm 1 250 mm Silver 15 pcs/carton
 6285 S 1 800 mm 2 250 mm Silver 15 pcs/carton

SHIFT STURMEY ARCHER UNIVERSAL

6478 G 1 800 mm 2 250 mm Black 15 pcs/carton
 6478-3 S 1 800 mm 2 250 mm Silver 15 pcs/carton

NEXUS 4/7/8 SPEED

6286 S 2 000 mm 2 250 mm Black 15 pcs/carton
 6287 S 2 000 mm 2 250 mm Silver 15 pcs/carton

SHIFT FOR ALL DERAILLEURS + NEXUS 3 SPEED

6479 S 2 000 mm 2 250 mm Black 15 pcs/carton
 6479-3 S 2 000 mm 2 250 mm Silver 15 pcs/carton

SHIFT SRAM UNIVERSAL

6477 G 1 800 mm 2 250 mm Black 15 pcs/carton



BRAKE

DISC BRAKE SYSTEMS
 CALIPER ADAPTERS
 DISC BRAKE ROTORS
 DISC BRAKE PARTS
 DISC BRAKE PADS
 RIM BRAKE PADS

CABLE

INNER CABLES
 OUTER CABLES
 ATB/RACE CABLES
 CABLE KITS
 CABLE PARTS

HYDRO

ORIGINAL BRANDS
 HYDRO COMPONENTS
 SHIMANO HYDRO COMPONENTS
 O-RINGS

ROTATION

BEARINGS
 HEADSET BEARINGS
 HEADSET PARTS
 PULLEY WHEELS
 BOTTOM BRACKET GUIDE
 BOTTOM BRACKETS
 BOTTOM BRACKET PARTS

TOOLS AND MAINTENANCE

MAINTENANCE
 CABLE TOOLS
 MORE TOOLS
 HYDRO TOOLS
 BOTTOM BRACKET TOOLS

WORKSHOP

TRANSIT
 BOXER
 PARTNER
 CADDY
 PADFINDER
 DISCOVERY

CABLE KITS

CABLE KIT DROPPER-POST AND LOCK-OUT REMOTES

(excl. remote)
2021081

L = 2.000mm



49 (7x7) strands slick
Extra flexible, extra smooth



FREESTYLE CABLE REAR

6489 1 pce



FREESTYLE CABLE FRONT

6484 1 pce

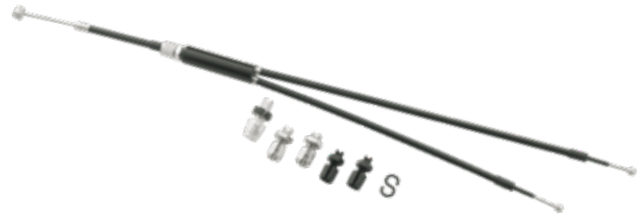

REPLACEMENT INNER CABLE (UPPER)

for universal cable splitter
6412/27RVS/1.35 Stainless 1 350 mm 20 pcs/carton

1x19 strands regular

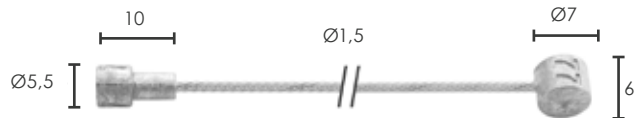

REPLACEMENT INNER CABLE (LOWER)

for universal cable splitter
2017145 Stainless 3 000 mm 15 pcs/carton

49 (7x7) strands extra flexible

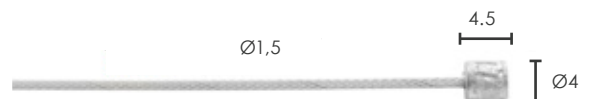

UNIVERSAL CABLE SPLITTER SET

2017161

Operates 2 brakes with 1 brake lever.

Includes a unique part (D) to add an optional ABS function.

Easy and quick assembly.

Inner cables included.
Outer cables not included.

- A** Body
- B** Cap
- C** Piston
- D** ABS insert
- E** O-ring
- F** M3 fixing bolt
- G** Allen key



- BRAKE**
- DISC BRAKE SYSTEMS
- CALIPER ADAPTERS
- DISC BRAKE ROTORS
- DISC BRAKE PARTS
- DISC BRAKE PADS
- RIM BRAKE PADS

- CABLE**
- INNER CABLES
- OUTER CABLES
- ATB/RACE CABLES
- CABLE KITS
- CABLE PARTS

- HYDRO**
- ORIGINAL BRANDS
- HYDRO COMPONENTS
- SHIMANO HYDRO COMPONENTS
- O-RINGS

- ROTATION**
- BEARINGS
- HEADSET BEARINGS
- HEADSET PARTS
- PULLEY WHEELS
- BOTTOM BRACKET GUIDE
- BOTTOM BRACKETS
- BOTTOM BRACKET PARTS

- TOOLS AND MAINTENANCE**
- MAINTENANCE
- CABLE TOOLS
- MORE TOOLS
- HYDRO TOOLS
- BOTTOM BRACKET TOOLS

- WORKSHOP**
- TRANSIT
- BOXER
- PARTNER
- CADDY
- PADFINDER
- DISCOVERY

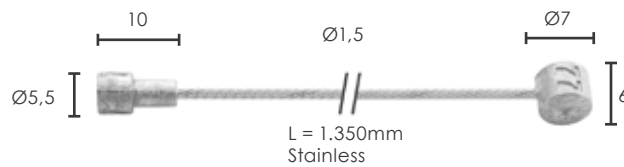

1x19 strands regular

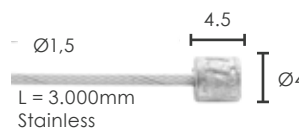
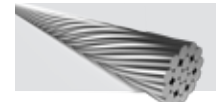

49 (7x7) strands extra flexible

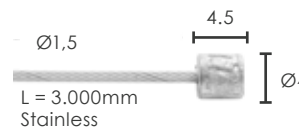

49 (7x7) strands extra flexible

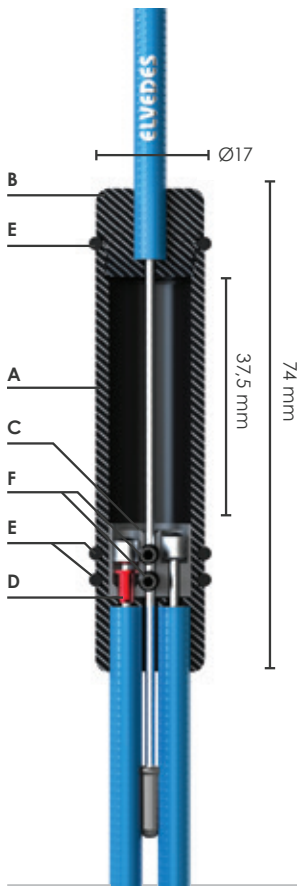

Scan this code for instructions



ASSORTMENT BOX COLOURED FERRULES AND END CAPS

2012020

For consumer packaging: CPxxxx

For workshop packaging: ELVxxxx

Contains:

100 aluminium end caps of each colour

25 aluminium ferrules of each size/colour



ELV2012001

Ferrule with seal

Ø5,0 mm

Aluminium

50 pcs



CP2012001 10 pcs

ELV2012007

Ferrule with seal

Ø4,3 mm

Aluminium

50 pcs



CP2012007 10 pcs

ELV1171

End cap

Ø2,3 mm

Aluminium

500 pcs



CP1171 10 pcs

ELV2012002

Ferrule with seal

Ø5,0 mm

Aluminium

50 pcs



CP2012002 10 pcs

ELV2012008

Ferrule with seal

Ø4,3 mm

Aluminium

50 pcs



CP2012008 10 pcs

ELV2012013

End cap

Ø2,3 mm

Aluminium

500 pcs



CP2012013 10 pcs

ELV2012004

Ferrule with seal

Ø5,0 mm

Aluminium

50 pcs



CP2012004 10 pcs

ELV2012010

Ferrule with seal

Ø4,3 mm

Aluminium

50 pcs



CP2012010 10 pcs

ELV2012015

End cap

Ø2,3 mm

Aluminium

500 pcs



CP2012015 10 pcs

ELV2012003

Ferrule with seal

Ø5,0 mm

Aluminium

50 pcs



CP2012003 10 pcs

ELV2012009

Ferrule with seal

Ø4,3 mm

Aluminium

50 pcs



CP2012009 10 pcs

ELV2012014

End cap

Ø2,3 mm

Aluminium

500 pcs



CP2012014 10 pcs

ELV2012006

Ferrule with seal

Ø5,0 mm

Aluminium

50 pcs



CP2012006 10 pcs

ELV2012012

Ferrule with seal

Ø4,3 mm

Aluminium

50 pcs



CP2012012 10 pcs

ELV2012017

End cap

Ø2,3 mm

Aluminium

500 pcs



CP2012017 10 pcs

ELV2012005

Ferrule with seal

Ø5,0 mm

Aluminium

50 pcs



CP2012005 10 pcs

ELV2012011

Ferrule with seal

Ø4,3 mm

Aluminium

50 pcs



CP2012011 10 pcs

ELV2012016

End cap

Ø2,3 mm

Aluminium

500 pcs



CP2012016 10 pcs

ALL PARTS AVAILABLE IN CONSUMER AND WORKSHOP PACKAGING

For consumer packaging: CPxxxx
For workshop packaging: ELVxxxx

ELV2016108

Ferrule

Ø4,3 to Ø4,75 mm
Brass
150 pcs



ELV2016107

Ferrule

Ø4,3 to Ø5,7 mm
Brass
150 pcs



CP2016107

10 pcs

ELV1160PRESSED

Ferrule

Ø5,0 mm
Brass
200 pcs



ELV1160

Ferrule CNC

Ø5,0 mm
Brass
200 pcs



CP1160

10 pcs

ELV1167

Ferrule push fit

Ø5,0 mm
Brass
200 pcs



ELV1130

Ferrule S.A.

Ø5,0 mm
Brass
50 pcs



ELV1001

Ferrule Weinmann

Ø5,5 mm
Aluminium
100 pcs



ELV1161

Ferrule with seal

Ø4,3 mm
Brass
100 pcs



ELV2015057

Ferrule with seal

Ø4,3 mm
PA6
100 pcs



ELV1160PVC4-1

Ferrule

Ø4,3 mm
PA6
150 pcs



CP1160PVC4-1

10 pcs

ELV1160PVC4-3

Ferrule

Ø4,3 mm
PA6
150 pcs



ELV1160PVC5-1

Ferrule

Ø5,0 mm
PA6
150 pcs



CP1160PVC5-1

10 pcs

ELV1160PVC5-3

Ferrule

Ø5,0 mm
PA6
150 pcs



ELV2012107

Ferrule with tip

Ø4,3 mm
PA6
50 pcs



ELV2012106

Ferrule with tip

Ø5 mm
PA6
50 pcs



ELV2018038

Ferrule with tip incl. rubber boot

Ø4,3 mm
PA6
25 pcs



ELV1071

Adjuster

M5
Brass
15 pcs



ELV1072

Adjuster

M6
Brass
15 pcs



BRAKE

DISC BRAKE SYSTEMS
CALIPER ADAPTERS
DISC BRAKE ROTORS
DISC BRAKE PARTS
DISC BRAKE PADS
RIM BRAKE PADS

CABLE

INNER CABLES
OUTER CABLES
ATB/RACE CABLES
CABLE KITS
CABLE PARTS

HYDRO

ORIGINAL BRANDS
HYDRO COMPONENTS
SHIMANO HYDRO COMPONENTS
O-RINGS

ROTATION

BEARINGS
HEADSET BEARINGS
HEADSET PARTS
PULLEY WHEELS
BOTTOM BRACKET GUIDE
BOTTOM BRACKETS
BOTTOM BRACKET PARTS

TOOLS AND MAINTENANCE

MAINTENANCE
CABLE TOOLS
MORE TOOLS
HYDRO TOOLS
BOTTOM BRACKET TOOLS

WORKSHOP

TRANSIT
BOXER
PARTNER
CADDY
PADFINDER
DISCOVERY

CABLE PARTS

ALL PARTS AVAILABLE IN CONSUMER AND WORKSHOP PACKAGING

For consumer packaging: CPxxxx
For workshop packaging: ELVxxxx

ELV1090

Adjuster
M6
Aluminium
25 pcs



ELV2015139

Adjuster barrel
Ø4,3 mm
Steel
15 pcs



CP2015139 2 pcs

ELV2015140

Adjuster barrel
Ø4,3 mm
Aluminium
15 pcs



CP2015140 2 pcs

ELV1073

Adjuster for cable
M6
Brass
10 pcs



ELV2020100

Adjuster for lever
M7
Aluminium
15 pcs



ELV2020099

Adjuster for lever
M10
Aluminium
15 pcs



ELV2011003

Adjuster for rollerbrake
M6
Brass
15 pcs



ELV2014062

Adjuster inline
Ø4,3 mm
Aluminium
15 pcs



CP2014062 2 pcs

ELV2015173

Adjuster inline
Ø5,0 mm
Aluminium
15 pcs



CP2015173 2 pcs

ELV2011004

Cable bolt for Nexus
4/7/8 speed
Brass
15 pcs



ELV2011002

Cable bolt for rollerbrake
BR-IM41/50/53
Brass
15 pcs



ELV2012024

Cable bolt for rollerbrake
BR-IM85/81/
80/55/45
Brass
15 pcs



ELV2012023

E-cap
Fits 2012024
POM
25 pcs



ELV1140

Cable bolt N-type
Ø7 × 10 mm
Brass
50 pcs



ELV1144

Cable bolt N-type
Ø8 × 14 mm
Brass
50 pcs



ELV1141

Cable bolt T-type
Ø5 × 7 mm
Brass
50 pcs



ELV1142

Cable bolt T-type
Ø6 × 14 mm
Brass
50 pcs



ELV1143

Cable bolt T-type
Ø8 × 15 mm
Brass
25 pcs



ELV6482/73

Linkwire
73 mm
Steel
10 pcs



ELV6482/82

Linkwire
82 mm
Steel
10 pcs



ELV6482/93

Linkwire
93 mm
Steel
10 pcs



ELV6482/106

Linkwire
106 mm
Steel
10 pcs



ELV1178

Open end cap
Ø5,0 mm
Aluminium
25 pcs



ELV1174

O-ring brake/shift
Ø1,1 - 1,5 mm
Rubber
250 pcs



ELV201211

Rubber boot
0,8 - 1,2 mm
Rubber
15 pcs



ELV1163

Rubber boot for V-brake
35 mm
Rubber
15 pcs



ELV2015143

Rubber boot for V-brake
35 mm
Rubber
15 pcs



ELV9009

Tensioner drumbrake universal
M4,5
Brass
10 pcs



ELV4545

Tensioner S.A. universal
25 mm
Brass
15 pcs



ELV5050

Tensioner SRAM T3
Ø1,5 mm
PA-GF
10 pcs



CP2019094

V-brake pipe 90° adjustable
Ø5,0 mm
Stainless steel
2 pcs



CP2019230

V-brake pipe 90° adjustable, short
Ø5,0 mm
Stainless steel
2 pcs



ELV2018061

V-brake pipe 90° black
Ø5,0 mm
Stainless steel
10 pcs



ELV1162-90

V-brake pipe 90°
Ø5,0 mm
Stainless steel
10 pcs



ELV1162-110

V-brake pipe 110°
Ø5,0 mm
Stainless steel
10 pcs



ELV1162-130

V-brake pipe 130°
Ø5,0 mm
Stainless steel
10 pcs



ELV1162

V-brake pipe flex
Ø5,0 mm
Stainless steel
10 pcs



ELV2012032

V-brake pipe flex incl. rubber boot
Ø5,0 mm
Stainless steel
10 pcs



CP2012032 1 pce

CP2017093

V-brake pipe flex, adjustable
Ø5,0 mm
Aluminium
2 pcs



BRAKE

DISC BRAKE SYSTEMS
CALIPER ADAPTERS
DISC BRAKE ROTORS
DISC BRAKE PARTS
DISC BRAKE PADS
RIM BRAKE PADS

CABLE

INNER CABLES
OUTER CABLES
ATB/RACE CABLES
CABLE KITS
CABLE PARTS

HYDRO

ORIGINAL BRANDS
HYDRO COMPONENTS
SHIMANO HYDRO COMPONENTS
O-RINGS

ROTATION

BEARINGS
HEADSET BEARINGS
HEADSET PARTS
PULLEY WHEELS
BOTTOM BRACKET GUIDE
BOTTOM BRACKETS
BOTTOM BRACKET PARTS

TOOLS AND MAINTENANCE

MAINTENANCE
CABLE TOOLS
MORE TOOLS
HYDRO TOOLS
BOTTOM BRACKET TOOLS

WORKSHOP

TRANSIT
BOXER
PARTNER
CADDY
PADFINDER
DISCOVERY

CABLE PARTS

ALL PARTS AVAILABLE IN CONSUMER AND WORKSHOP PACKAGING

For consumer packaging: CPxxxx
For workshop packaging: ELVxxxx

ELV2020102

Cable clip duo
4,1 + 4,1 mm
PA6
50 pcs



CP2020102

10 pcs

ELV2020101

Cable clip duo
5,0 + 2,5 mm (Di2)
PA6
50 pcs



CP2020101

10 pcs

ELV2020103

Cable clip duo
5,0 + 4,1 mm
PA6
50 pcs



CP2020103

10 pcs

ELV2020104

Cable clip duo
5,0 + 5,0 mm
PA6
50 pcs



CP2020104

10 pcs

ELV1075

Cable clip
Ø5,0 mm
PP
20 pcs



ELV2015142

Cable clip for frame notch
Ø5,0 mm
50 pcs



CP2015142

2 pcs

ELV2015141

Cable clip rotating
Ø4,3 - 5,0 mm
50 pcs



CP2015141

4 pcs

CP2019093

Cable guide pipe short
Ø5,0 mm
Aluminium
2 pcs



CP2015144

Cable hanger for cyclo-cross
Aluminium
1 pce



ELV6464

Cantilever cable
Ø1,5 mm
extra flexible
Stainless steel
20 pcs



ELV2019095

Cantilever cable bolt
Brass
10 pcs



2010015

Dual brake lever with parking stop
Ø23 mm
Steel
1 pce



ELV1171

End cap
Ø2,3 mm
Aluminium
500 pcs



CP1171

10 pcs

ELV1172

End cap
Ø1,6 mm
Aluminium
500 pcs



CP1172

10 pcs

ELV2018036

Extension ferrule
Ø4,3 mm
Aluminium
25 pcs



ELV2018035

Extension ferrule
Ø5,0 mm
Aluminium
25 pcs



ELV1176

Frame protector
Ø4,3 - 5,0 mm
Rubber
25 pcs



ELV2011001

Frame protector
Ø4,3 - 5,0 mm
Rubber
25 pcs



CP2011001

4 pcs

CABLE LINER

2016116

Ø2.0 / 2.6 mm
L= 25mtr
HDPE



CABLE LINER WITH TRUMPET

2018099

Ø2.5 / 2.0 mm
L= 300mm
HDPE
10 pcs



2018100

Ø2.5 / 2.0 mm
L= 1.000mm
HDPE
10 pcs



INNER LINER BRAKE

2018098

Ø2.5/2.0mm
L=1.000mm
HDPE Liner + ferrule
2 pcs



INNER LINER SHIFT

2018097

Ø2.0/1.4mm
L=750mm
HDPE Liner + ferrule
2 pcs



ANTI-RATTLE FOAM

2018015

Ø11.0/6.0mm
L=750mm
10 pcs in sealbag
Foam to prevent rattling
internal cables and hoses



SPIRAL WRAP TUBE

10 meter

| | | |
|---------|-------|------------------|
| 2018031 | Ø4mm | bundles 3-8 mm |
| 2018032 | Ø6mm | bundles 5-10 mm |
| 2018033 | Ø12mm | bundles 9-65 mm |
| 2018034 | Ø15mm | bundles 12-70 mm |



BRAKE

- DISC BRAKE SYSTEMS
- CALIPER ADAPTERS
- DISC BRAKE ROTORS
- DISC BRAKE PARTS
- DISC BRAKE PADS
- RIM BRAKE PADS

CABLE

- INNER CABLES
- OUTER CABLES
- ATB/RACE CABLES
- CABLE KITS
- CABLE PARTS

HYDRO

- ORIGINAL BRANDS
- HYDRO COMPONENTS
- SHIMANO HYDRO COMPONENTS
- O-RINGS

ROTATION

- BEARINGS
- HEADSET BEARINGS
- HEADSET PARTS
- PULLEY WHEELS
- BOTTOM BRACKET GUIDE
- BOTTOM BRACKETS
- BOTTOM BRACKET PARTS

TOOLS AND MAINTENANCE

- MAINTENANCE
- CABLE TOOLS
- MORE TOOLS
- HYDRO TOOLS
- BOTTOM BRACKET TOOLS

WORKSHOP

- TRANSIT
- BOXER
- PARTNER
- CADDY
- PADFINDER
- DISCOVERY

HYDRO



ORIGINAL BRAND HOSE EXTENSION SET

Extend original brand hydro hoses with fitting sets per brand. Packed in a sealbag.

ELV2020240

6 pcs extension nipples
12 pcs compression bolts
Fits any original hose
Use with compatible fittings



2019101

Shimano
SM-BH59 and SM-BH90



2019102

Magura



2019103

SRAM / Avid



2019104

Tektro



2019105

Formula



2019106

Hayes



BRAKE

- DISC BRAKE SYSTEMS
- CALIPER ADAPTERS
- DISC BRAKE ROTORS
- DISC BRAKE PARTS
- DISC BRAKE PADS
- RIM BRAKE PADS

CABLE

- INNER CABLES
- OUTER CABLES
- ATB/RACE CABLES
- CABLE KITS
- CABLE PARTS

HYDRO

- ORIGINAL BRANDS
- HYDRO COMPONENTS
- SHIMANO HYDRO COMPONENTS
- O-RINGS

ROTATION

- BEARINGS
- HEADSET BEARINGS
- HEADSET PARTS
- PULLEY WHEELS
- BOTTOM BRACKET GUIDE
- BOTTOM BRACKETS
- BOTTOM BRACKET PARTS

TOOLS AND MAINTENANCE

- MAINTENANCE
- CABLE TOOLS
- MORE TOOLS
- HYDRO TOOLS
- BOTTOM BRACKET TOOLS

WORKSHOP

- TRANSIT
- BOXER
- PARTNER
- CADDY
- PADFINDER
- DISCOVERY

ASSORTMENT BOX ORIGINAL BRAND HOSE FITTINGS

2015145

With this box, any original hose of Tektro, Shimano, Avid, SRAM, Hayes, Formula and Magura (except HS11/33) can be shortened. Contains parts to shorten 10 hoses per brand. 60 pieces in total.



ELV-AV01

Compression bolt

Avid
10 pcs



ELV-FM01

Compression bolt

Formula
10 pcs



ELV-FM04

Compression bolt
M8 x 1

Formula
10 pcs



ELV-HY01

Compression bolt

Hayes
10 pcs



ELV-MG01

Compression bolt

Magura
10 pcs



ELV-MG04

Compression bolt
M9

Magura
10 pcs



ELV-SH01

Compression bolt

Shimano
10 pcs



ELV-TK01

Compression bolt

Tektro
10 pcs



ELV-AV02-1

Olive

Avid
10 pcs



ELV-FM02

Olive

Formula
10 pcs



ELV-HY03

Olive

Hayes
10 pcs



ELV-MG02

Olive

Magura
10 pcs



ELV-SH02

Olive

Shimano
10 pcs



ELV-TK02

Olive

Tektro
10 pcs



ELV-AV03-1

Insert

Avid
10 pcs



ELV-FM03

Insert

Formula
10 pcs



ELV-HY02

Insert with olive

Hayes
10 pcs



ELV-MG03

Insert

Magura
10 pcs



ELV-SH03

Insert SM-BH59

Shimano
10 pcs



ELV-SH04

Insert SM-BH90

Shimano
10 pcs



ELV-TK03

Insert

Tektro
10 pcs



ELV-HP02

Olive

Hope
10 pcs



ELV-HP03

Insert

Hope
10 pcs



ELV-HP04

O-ring
(small)

Hope
10 pcs



ELV-HP05

O-ring
(large)

Hope
10 pcs



ORIGINAL BRAND HOSE FITTING SET

Shorten 2 original brand hydro hoses with fitting sets per brand. Packed in a sealbag.

CP2019130

Shimano
SM-BH59



CP2019131

Shimano
SM-BH90



CP2019132

Magura



CP2019133

SRAM / Avid



CP2019134

Tektro



CP2019135

Formula



CP2019136

Hayes



CP2020139

Elvedes



CP2021069

Hope



BRAKE

DISC BRAKE SYSTEMS

CALIPER ADAPTERS

DISC BRAKE ROTORS

DISC BRAKE PARTS

DISC BRAKE PADS

RIM BRAKE PADS

CABLE

INNER CABLES

OUTER CABLES

ATB/RACE CABLES

CABLE KITS

CABLE PARTS

HYDRO

ORIGINAL BRANDS

HYDRO
COMPONENTS

SHIMANO HYDRO
COMPONENTS

O-RINGS

ROTATION

BEARINGS

HEADSET BEARINGS

HEADSET PARTS

PULLEY WHEELS

BOTTOM BRACKET
GUIDE

BOTTOM BRACKETS

BOTTOM BRACKET
PARTS

TOOLS AND MAINTENANCE

MAINTENANCE

CABLE TOOLS

MORE TOOLS

HYDRO TOOLS

BOTTOM BRACKET
TOOLS

WORKSHOP

TRANSIT

BOXER

PARTNER

CADDY

PADFINDER

DISCOVERY

HYDRO COMPONENTS

HYDRO HOSE VOLUME BOX

20 meters hose

With Kevlar and PTFE
Suitable for mineral and DOT oil
Fits Elvedes parts only

2012030 Black

2012031 White



ASSORTMENT BOX HYDRO PARTS

2012096

Assortment box which contains all hydraulic parts and accessories for Elvedes hydro hose only



ELV2017095

Compression bolt
M9 x 1.25

Stainless steel

10 pcs



ELV2019115

Banjo bolt

Stainless steel

10 pcs



ELV2012097

Insert

Brass

30 pcs



ELV2012100

Connector M6

Stainless steel

10 pcs



ELV2012101

Banjo

Stainless steel

10 pcs



ELV2012104

Banjo bolt

Steel

10 pcs



ELV2012098

Olive

Brass

40 pcs



ELV2012099

Compression bolt
M8 x 0.75

Stainless steel

30 pcs



ELV2012103

Banjo bolt

Stainless steel

10 pcs



ELV2019116

Flange bolt M9

Steel

10 pcs



ELV2012102

Compression nut

Stainless steel

10 pcs



ELV2012105

O-ring





Copper

30 pcs



HYDRO HOSE

3 meters hose.
For both front and rear brakes.
Suitable for mineral and DOT oil.
Fits Elvedes parts only

| | | |
|---------|--------|---|
| 2011006 | Black |  |
| 2011007 | White |  |
| 2011008 | Red |  |
| 2011009 | Orange |  |
| 2011010 | Blue |  |
| 2011011 | Green |  |



HYDRO PARTS KIT

Stainless Steel Parts.
For both front and rear brakes.
Fits Elvedes Hydro hose only

| | |
|---------|--|
| 2011012 | Kit 1 : M8 + M8 |
| 2011013 | Kit 2 : M8 + Banjo |
| 2011014 | Kit 3 : Banjo + Banjo |
| 2011015 | Kit 4 : M8 + M6 |
| 2016025 | Kit 5 : M8 + Banjo (Shimano) |
| 2016009 | Kit 6 : M8 X 1 + Banjo (New Form Mega/R/R1/R1R/Cura) |
| 2016010 | Kit 7 : M9 X 1.25 + Banjo (Mag. MT 4/5/5e/6/7/8) |
| 2016011 | Kit 8 : M9 X 1.25 + M6 (Mag. MT2) |
| 2019122 | Kit 9 : M9 Flange bolt + M8 |



FIT YOUR KIT

Avid/SRAM

| | |
|-------------------------------|-------|
| Code, New Code, Juicy 3 | Kit 1 |
| All other Juicy, XX 2010-2011 | Kit 2 |
| Elixir, XO, XX 2012, Guide | Kit 4 |

Hayes

| | |
|--|-------|
| Sole, Dyno | Kit 1 |
| All Stroker, all Prime, Trail, Carbon, Ace | Kit 2 |
| Nine HFX-9 | Kit 4 |

Magura

| | |
|---------------------------------|-------|
| Gustav | Kit 2 |
| Louise, Julie, Marta, New Marta | Kit 4 |
| MT 4 / 5 / 5E / 6 / 7 / 8 | Kit 7 |
| MT 2, MT Sport | Kit 8 |

Elvedes

| | |
|--------|-------|
| HP4000 | Kit 1 |
|--------|-------|

Formula

| | |
|------------------------|-------|
| RX, R1, The One, Mega | Kit 2 |
| Oro | Kit 3 |
| Mega, R, R1, R1R, Cura | Kit 6 |

Tektro

| | |
|---------------------------------|-------|
| All Draco, Auriga Comp (WS) | Kit 1 |
| Orion, Volans, all other Auriga | Kit 2 |

Shimano

| | |
|--|-------|
| MT200, M485, M486, M525, M535, M585, M595, M601, M665 M775, R785, M975 | Kit 1 |
| M755, M765, M776, RS785, M640, M800, M810, M988 | Kit 2 |
| M965, M966 | Kit 3 |
| M666, M675, M785, M985, M7000, M8000 | Kit 5 |
| ST-R9170, ST-R8070, ST-RX810, ST-R7070, ST-4770, ST-R400, ST-R9120, ST-R8020 | Kit 9 |

BRAKE

- DISC BRAKE SYSTEMS
- CALIPER ADAPTERS
- DISC BRAKE ROTORS
- DISC BRAKE PARTS
- DISC BRAKE PADS
- RIM BRAKE PADS

CABLE

- INNER CABLES
- OUTER CABLES
- ATB/RACE CABLES
- CABLE KITS
- CABLE PARTS

HYDRO

- ORIGINAL BRANDS
- HYDRO COMPONENTS
- SHIMANO HYDRO COMPONENTS
- O-RINGS

ROTATION

- BEARINGS
- HEADSET BEARINGS
- HEADSET PARTS
- PULLEY WHEELS
- BOTTOM BRACKET GUIDE
- BOTTOM BRACKETS
- BOTTOM BRACKET PARTS

TOOLS AND MAINTENANCE

- MAINTENANCE
- CABLE TOOLS
- MORE TOOLS
- HYDRO TOOLS
- BOTTOM BRACKET TOOLS

WORKSHOP

- TRANSIT
- BOXER
- PARTNER
- CADDY
- PADFINDER
- DISCOVERY

SHIMANO HYDRO COMPONENTS

REPLACING

2020106

With Kevlar and PTFE



L = 2000mm

2020107

With Kevlar and PTFE



L = 2000mm

2021082

Brake hose for Shimano SM-BH59
With Kevlar and PTFE
20 m

2020138

Brake hose for Shimano SM-BH90
With Kevlar and PTFE
20 m



REPLACING / SHORTENING

CP2019130

Fitting set SM-BH59



CP2019131

Fitting set SM-BH90



ELV-SH03

Insert SM-BH59



ELV-SH04

Insert SM-BH90



ELV-SH02

Olive



ELV-SH01

Compression bolt



EXTENDING

2019101

SM-BH59 and SM-BH90



L = 500mm

BLEEDING

Mineral oil red

2016005 100 ml
2015169 250 ml
2020238 1 000 ml



Mineral oil syringes

2018040
2 pcs



Bleed adapter set

2020095



Bleed nipple cap

2017186
10 pcs



ASSORTMENT BOX O-RINGS

2019240

Replacement o-rings for calipers and master cylinders.
Blue rings for mineral oil
Black rings for DOT oil

Contains 20 pieces of each o-ring



2019241

Shimano R785, XTR
M9000/9020, SLX M7000,
Deore XT M8000/8020,
Alfine S7000
10 pcs



2019242

Shimano Deore, XT, XTR
10 pcs



2019107

Magura MT4/5/6/7/8, Tektro
Orion (SL), Volans, Auriga
(SUB, Tune, Twin), Dorado,
Gemini SL
10 pcs



2019108

Magura MT4
10 pcs



2019109

SRAM Elixir 5, Guide
Ultimate, HydroR for
flatmount
10 pcs



2019110

SRAM Elixir 7/9, XO (Trail),
XX (World Cup), HydroR for
postmount
10 pcs



2019111

SRAM Elixir 7/9, XO (Trail),
XX (World Cup), HydroR for
postmount and Formula R1,
The One, Mega
10 pcs



2019112

SRAM Elixir 5 and Formula
The One
10 pcs



2019113

Formula RX
10 pcs



2019114

Hayes Prime, HFX-9, HFX-
MAG
10 pcs



BRAKE

DISC BRAKE SYSTEMS
CALIPER ADAPTERS
DISC BRAKE ROTORS
DISC BRAKE PARTS
DISC BRAKE PADS
RIM BRAKE PADS

CABLE

INNER CABLES
OUTER CABLES
ATB/RACE CABLES
CABLE KITS
CABLE PARTS

HYDRO

ORIGINAL BRANDS
HYDRO
COMPONENTS
SHIMANO HYDRO
COMPONENTS
O-RINGS

ROTATION

BEARINGS
HEADSET BEARINGS
HEADSET PARTS
PULLEY WHEELS
BOTTOM BRACKET
GUIDE
BOTTOM BRACKETS
BOTTOM BRACKET
PARTS

TOOLS AND MAINTENANCE

MAINTENANCE
CABLE TOOLS
MORE TOOLS
HYDRO TOOLS
BOTTOM BRACKET
TOOLS

WORKSHOP

TRANSIT
BOXER
PARTNER
CADDY
PADFINDER
DISCOVERY

ROTATION

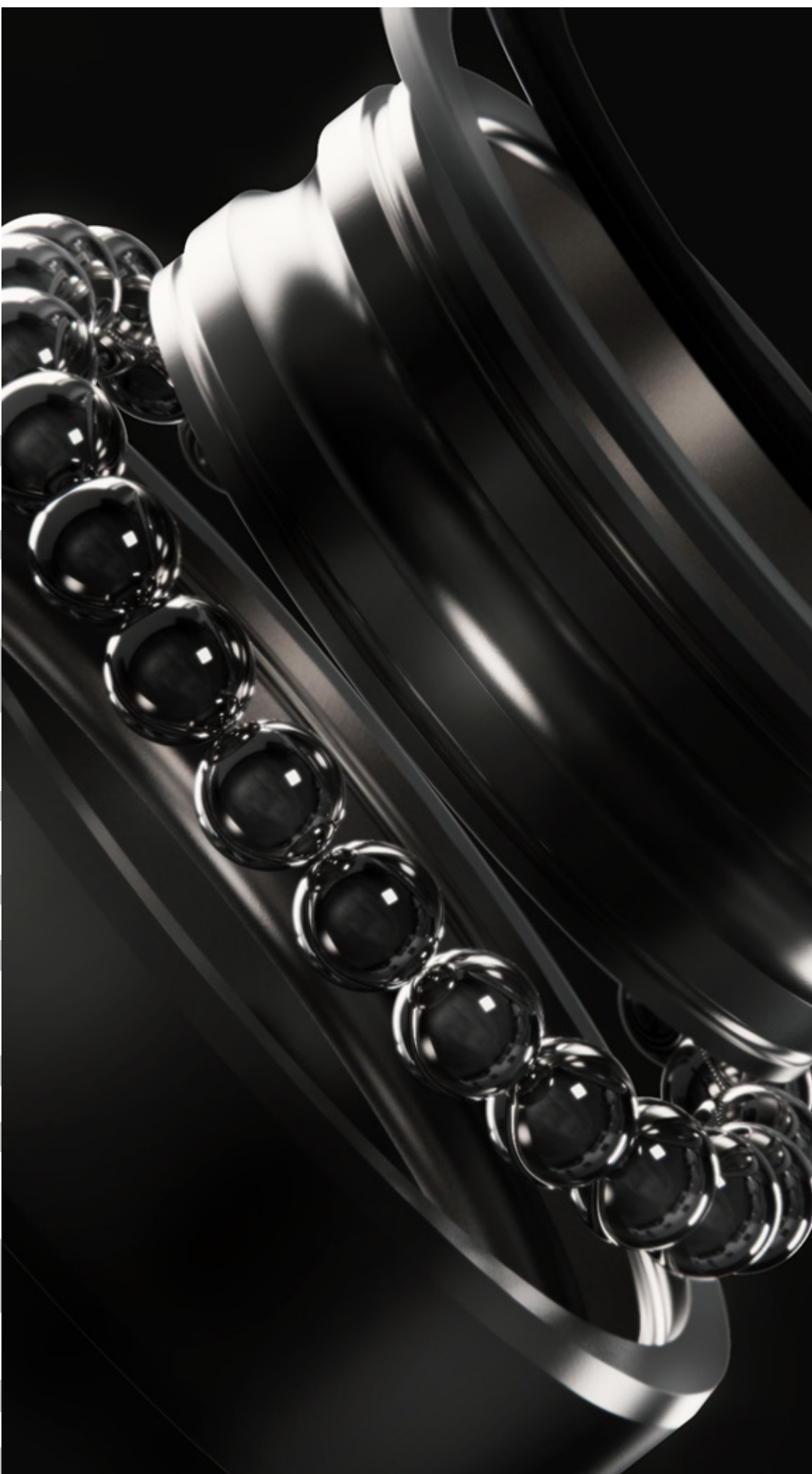

INDUSTRIAL BEARING

- Balls separated by cage
- For full rotation parts
- ABEC 3



INDUSTRIAL STEEL BEARINGS

| | | |
|---------|-----------|----------------|
| 2017103 | 608 2RS | Ø22 × Ø8 × 7 |
| 2017104 | 609 2RS | Ø24 × Ø9 × 7 |
| 2017105 | 688 2RS | Ø16 × Ø8 × 5 |
| 2017106 | 699 2RS | Ø20 × Ø9 × 6 |
| 2017107 | 6000 2RS | Ø26 × Ø10 × 8 |
| 2017108 | 6001 2RS | Ø28 × Ø12 × 8 |
| 2021051 | 6002 2RS | Ø31 × Ø16 × 10 |
| 2017109 | 6800 2RS | Ø19 × Ø10 × 5 |
| 2017110 | 6801 2RS | Ø21 × Ø12 × 5 |
| 2017111 | 6802 2RS | Ø24 × Ø15 × 5 |
| 2017112 | 6803 2RS | Ø26 × Ø17 × 5 |
| 2017113 | 6804 2RS | Ø32 × Ø20 × 7 |
| 2017114 | 6805 2RS | Ø37 × Ø25 × 7 |
| 2017115 | 6806 2RS | Ø42 × Ø30 × 7 |
| 2017116 | 6900 2RS | Ø22 × Ø10 × 6 |
| 2017117 | 6901 2RS | Ø24 × Ø12 × 6 |
| 2017118 | 6902 2RS | Ø28 × Ø15 × 7 |
| 2017119 | 6903 2RS | Ø30 × Ø17 × 7 |
| 2017120 | 6904 2RS | Ø37 × Ø20 × 9 |
| 2017121 | 15267 2RS | Ø26 × Ø15 × 7 |
| 2020070 | 15268 2RS | Ø26 × Ø15 × 8 |
| 2017195 | 16100 2RS | Ø28 × Ø10 × 8 |
| 2017122 | 17287 2RS | Ø28 × Ø17 × 7 |
| 2018039 | 18307 2RS | Ø30 × Ø18 × 7 |
| 2017194 | 24377 2RS | Ø37 × Ø24 × 7 |

Steel bearing balls

| | | |
|---------|-------|-------------|
| 2021075 | 1/8" | 100 pcs/bag |
| 2021076 | 5/32" | 100 pcs/bag |
| 2021077 | 3/16" | 100 pcs/bag |
| 2021078 | 1/4" | 100 pcs/bag |

MAX BEARING

- Max amount of balls
- For minimum rotation parts
- For heavy loads
- ABEC 3



MAX STEEL BEARINGS

| | | |
|---------|---------------|----------------|
| 2020052 | 606 2RS MAX | Ø17 × Ø6 × 6 |
| 2020053 | 608 2RS MAX | Ø22 × Ø8 × 7 |
| 2020054 | 688 2RS MAX | Ø16 × Ø8 × 5 |
| 2020055 | 698 2RS MAX | Ø19 × Ø8 × 6 |
| 2021018 | 3802 2RS MAX | Ø24 × Ø15 × 7 |
| 2021019 | 3803 2RS MAX | Ø26 × Ø17 × 7 |
| 2020066 | 3802W 2RS MAX | Ø24 × Ø15 × 10 |
| 2020067 | 3803W 2RS MAX | Ø26 × Ø17 × 10 |
| 2020056 | 6000 2RS MAX | Ø26 × Ø10 × 8 |
| 2020057 | 6001 2RS MAX | Ø28 × Ø12 × 8 |
| 2020058 | 6003 2RS MAX | Ø35 × Ø17 × 10 |
| 2020059 | 6800 2RS MAX | Ø19 × Ø10 × 5 |
| 2020060 | 6802 2RS MAX | Ø24 × Ø15 × 5 |
| 2021049 | 6803 2RS MAX | Ø26 × Ø17 × 5 |
| 2020061 | 6805 2RS MAX | Ø37 × Ø25 × 7 |
| 2021050 | 6806 2RS MAX | Ø42 × Ø30 × 7 |
| 2020062 | 6900 2RS MAX | Ø22 × Ø10 × 6 |
| 2020063 | 6901 2RS MAX | Ø24 × Ø12 × 6 |
| 2020064 | 6902 2RS MAX | Ø28 × Ø15 × 7 |
| 2020065 | 6903 2RS MAX | Ø30 × Ø17 × 7 |
| 2020069 | 10197 2RS MAX | Ø19 × Ø10 × 7 |
| 2020068 | 17286 2RS MAX | Ø28 × Ø17 × 6 |



BRAKE

- DISC BRAKE SYSTEMS
- CALIPER ADAPTERS
- DISC BRAKE ROTORS
- DISC BRAKE PARTS
- DISC BRAKE PADS
- RIM BRAKE PADS

CABLE

- INNER CABLES
- OUTER CABLES
- ATB/RACE CABLES
- CABLE KITS
- CABLE PARTS

HYDRO

- ORIGINAL BRANDS
- HYDRO COMPONENTS
- SHIMANO HYDRO COMPONENTS
- O-RINGS

ROTATION

- BEARINGS
- HEADSET BEARINGS
- HEADSET PARTS
- PULLEY WHEELS
- BOTTOM BRACKET GUIDE
- BOTTOM BRACKETS
- BOTTOM BRACKET PARTS

TOOLS AND MAINTENANCE

- MAINTENANCE
- CABLE TOOLS
- MORE TOOLS
- HYDRO TOOLS
- BOTTOM BRACKET TOOLS

WORKSHOP

- TRANSIT
- BOXER
- PARTNER
- CADDY
- PADFINDER
- DISCOVERY

BEARINGS

TYPE 688

Ø16 × Ø8 × 5
Industrial: **2017105**
MAX: **2020054**



TYPE 606

Ø17 × Ø6 × 6
Industrial: N/A
MAX: **2020052**



TYPE 698

Ø19 × Ø8 × 6
Industrial: N/A
MAX: **2020055**



TYPE 6800

Ø19 × Ø10 × 5
Industrial: **2017109**
MAX: **2020059**



TYPE 10197

Ø19 × Ø10 × 7
Industrial: N/A
MAX: **2020069**



TYPE 699

Ø20 × Ø9 × 6
Industrial: **2017106**
MAX: N/A



TYPE 6801

Ø21 × Ø12 × 5
Industrial: **2017110**
MAX: N/A



TYPE 608

Ø22 × Ø8 × 7
Industrial: **2017103**
MAX: **2020053**



TYPE 6900

Ø22 × Ø10 × 6
Industrial: **2017116**
MAX: **2020062**



TYPE 609

Ø24 × Ø9 × 7
Industrial: **2017104**
MAX: N/A



TYPE 6901

Ø24 × Ø12 × 6
Industrial: **2017117**
MAX: **2020063**



TYPE 6802

Ø24 × Ø15 × 5
Industrial: **2017111**
MAX: **2020060**

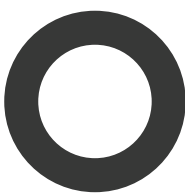

TYPE 3802

Ø24 × Ø15 × 7
Industrial: N/A
MAX: **2021018**

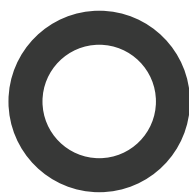

TYPE 3802

Ø24 × Ø15 × 10
Industrial: N/A
MAX: **2020066**

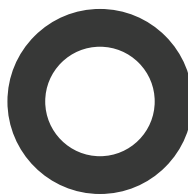

TYPE 6000

Ø26 × Ø10 × 8
Industrial: **2017107**
MAX: **2020056**



TYPE 15267

Ø26 × Ø15 × 7
Industrial: **2017121**
MAX: N/A

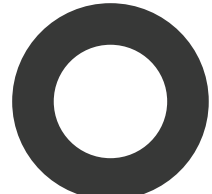

TYPE 15268

Ø24 × Ø15 × 8
Industrial: **2020070**
MAX: N/A



TYPE 6803

Ø26 × Ø17 × 5
Industrial: **2017112**
MAX: **2021049**

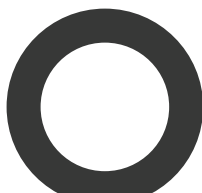

TYPE 3803

Ø26 × Ø17 × 7
Industrial: N/A
MAX: **2021019**

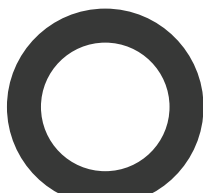

TYPE 3803w

Ø26 × Ø17 × 10
Industrial: N/A
MAX: **2020067**

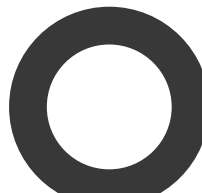

TYPE 16100

Ø28 × Ø10 × 8
Industrial: **2017195**
MAX: N/A



TYPE 6001

Ø28 × Ø12 × 8
Industrial: **2017108**
MAX: **2020057**

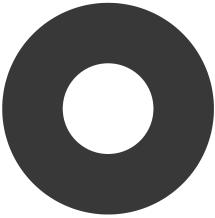

TYPE 6902

Ø28 × Ø15 × 7
Industrial: **2017118**
MAX: **2020064**



TYPE 17286

Ø28 × Ø17 × 6
Industrial: N/A
MAX: **2020068**

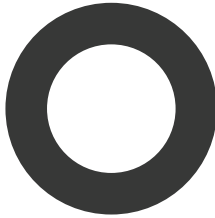

TYPE 17287

Ø28 × Ø17 × 7
Industrial: **2017122**
MAX: N/A

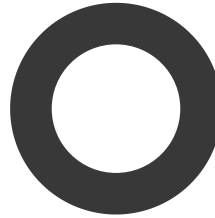

TYPE 6903

Ø30 × Ø17 × 7
Industrial: **2017119**
MAX: **2020065**



TYPE 18307

Ø30 × Ø18 × 7
Industrial: **2018039**
MAX: N/A

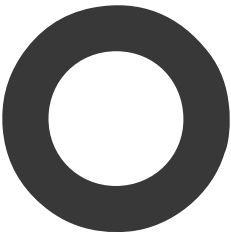

TYPE 6002

Ø31 × Ø16 × 10
Industrial: **2021051**
MAX: N/A



TYPE 6804

Ø32 × Ø20 × 7
Industrial: **2017113**
MAX: N/A

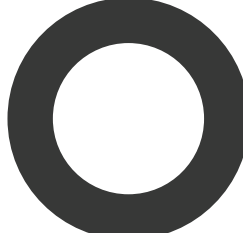

TYPE 6003

Ø35 × Ø17 × 10
Industrial: N/A
MAX: **2020058**



TYPE 6904

Ø37 × Ø20 × 9
Industrial: **2017120**
MAX: N/A



TYPE 24377

Ø37 × Ø24 × 7
Industrial: **2017194**
MAX: N/A

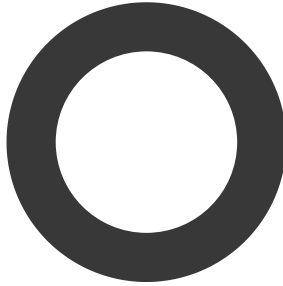

TYPE 6805

Ø37 × Ø25 × 7
Industrial: **2017114**
MAX: **2020061**

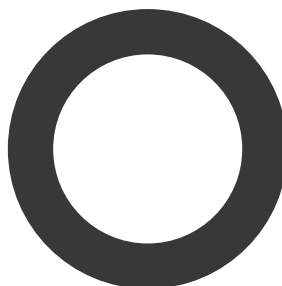

TYPE 6806

Ø42 × Ø30 × 7
Industrial: **2017115**
MAX: **2021050**

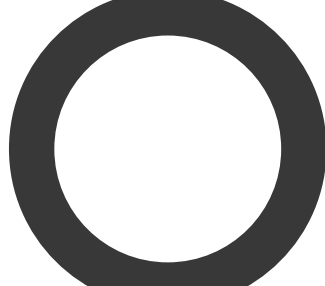

HEADSET BEARINGS

TYPE MR168

1-1/4" $\varnothing 46,8 \times \varnothing 34 \times 7$ $45^\circ \times 45^\circ$
2017138

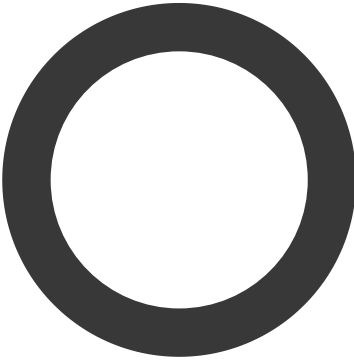

TYPE MR137

1-1/4" $\varnothing 46,9 \times \varnothing 37 \times 7$ $45^\circ \times 45^\circ$
2019050

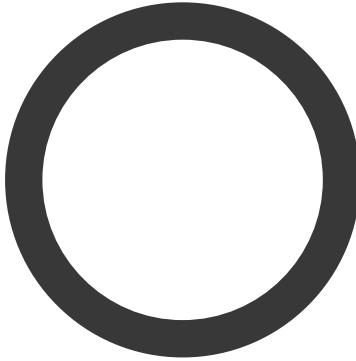

TYPE MR151

1-3/8" $\varnothing 48,9 \times \varnothing 37 \times 7$ $45^\circ \times 45^\circ$
2017139

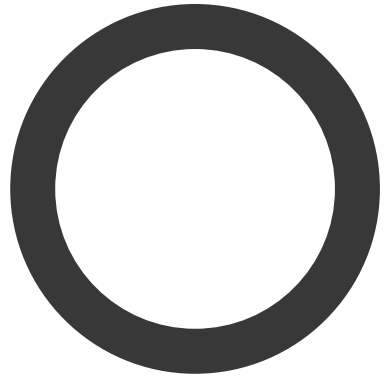

TYPE MR006

1,5" $\varnothing 51 \times \varnothing 40 \times 6,5$ $36^\circ \times 36^\circ$
2017142

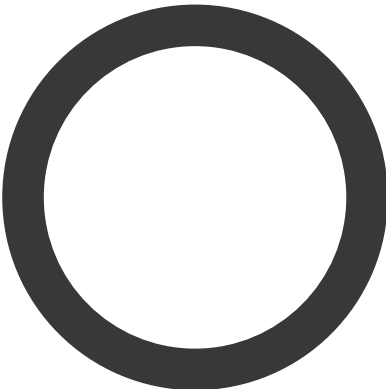

TYPE MR127

1,5" $\varnothing 51,8 \times \varnothing 40 \times 8$ $36^\circ \times 45^\circ$
2017140

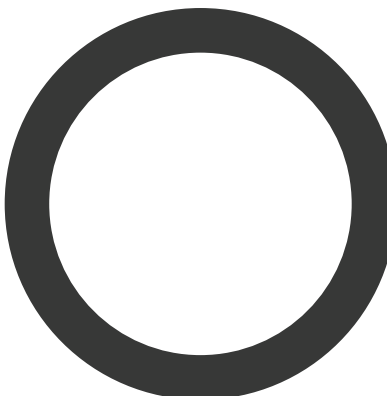

TYPE MR019

1,5" $\varnothing 51,8 \times \varnothing 40 \times 7,5$ $36^\circ \times 45^\circ$
2017141

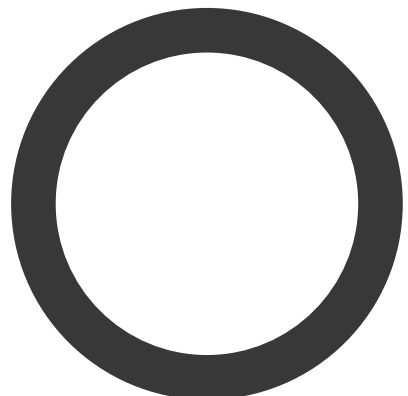

TYPE MR170

1,5" $\varnothing 52 \times \varnothing 40 \times 7$ $45^\circ \times 45^\circ$
2017134

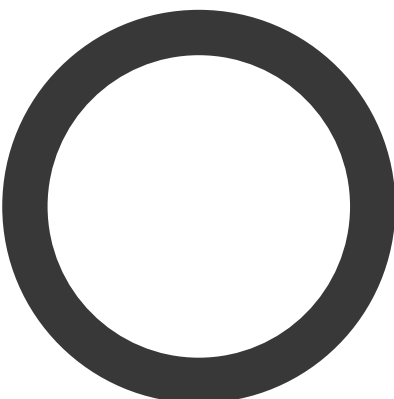

TYPE MR171

1,5" $\varnothing 52 \times \varnothing 40 \times 7,5$ $45^\circ \times 45^\circ$
2017143

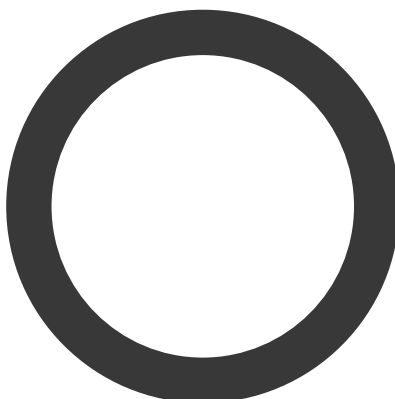

1,5" $\varnothing 52 \times \varnothing 40 \times 6,5$ $45^\circ \times 45^\circ$
2020049

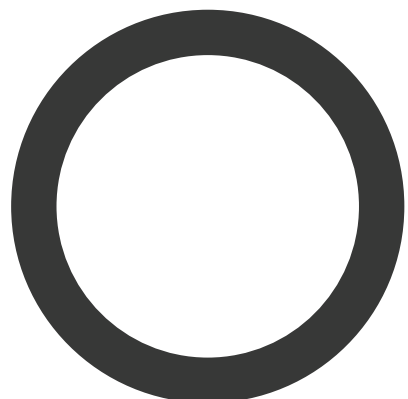

1-1/8" Ø41 x Ø30.15 x 7 36° x 45°
2017247

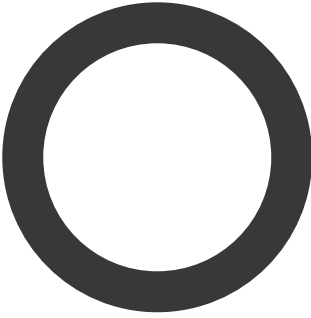

TYPE MR122
1-1/8" Ø41 x Ø30.2 x 6.5 36° x 45°
2017135

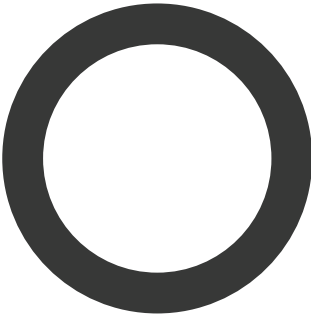

TYPE MR155
1-1/8" Ø41.8 x Ø30.7 x 7.7 45° x 45°
2019049

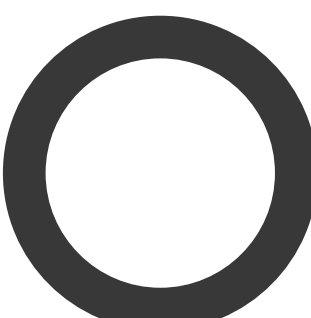

1-1/8" Ø41.8 x Ø30.2 x 6.5 45° x 45°
2020048

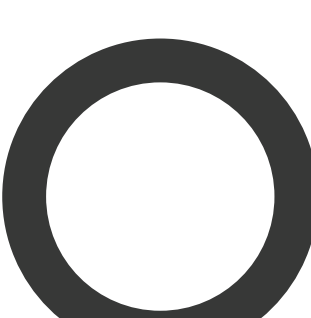

1-1/8" Ø41 x Ø30.15 x 7 45° x 45°
2019051

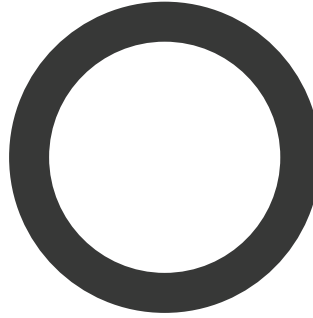

TYPE MR043
1-1/8" Ø41.5 x Ø30.15 x 6.5 36° x 36°
2017136

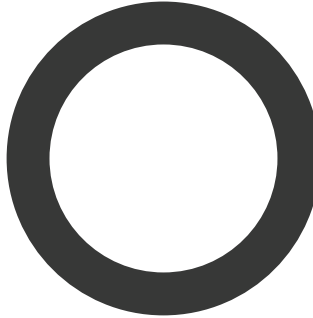

TYPE MR136
1-1/4" Ø41.8 x Ø32.8 x 6 45° x 45°
2019052

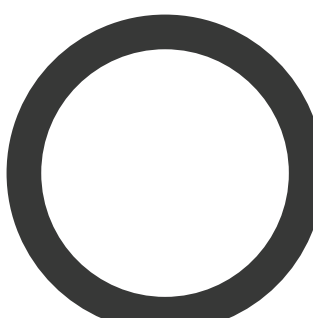

1-1/4" Ø44 x Ø35 x 5
2020050

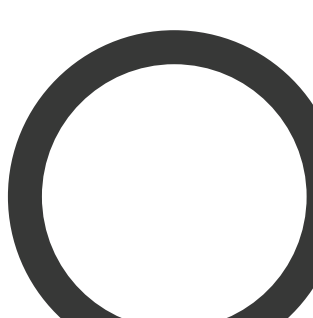

1-1/8" Ø41 x Ø30.15 x 7.7 36° x 45°
2019053

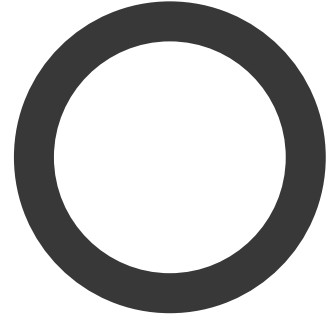

TYPE MR121
1-1/8" Ø41.8 x Ø30.5 x 8 45° x 45°
2017137

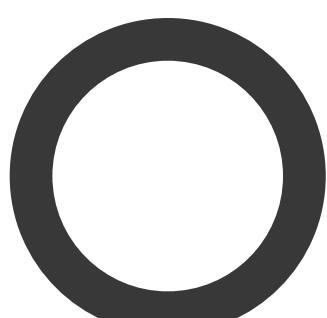

1-1/4" Ø46 x Ø34.1 x 7 45° x 45°
2017246

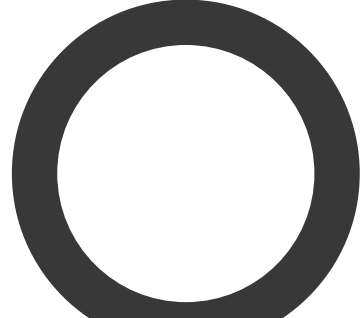

1-3/8" Ø48 x Ø37 x 7
2020051

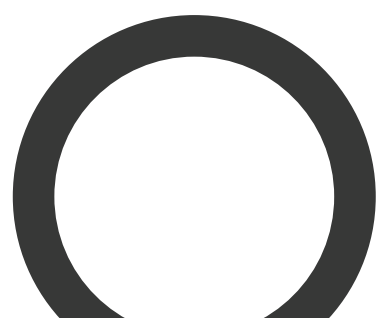

HEADSET BEARINGS

HEADSET BEARINGS

2019096

Assortment box high precision headset bearings

Contains 2 pcs of:

| | | |
|---------|---------|---------|
| 2017134 | 2017140 | 2019049 |
| 2017135 | 2017141 | 2019050 |
| 2017136 | 2017142 | 2019051 |
| 2017137 | 2017143 | 2019052 |
| 2017138 | 2017246 | 2019053 |
| 2017139 | 2017247 | |

Contains 10 pcs micro spacers
Refill per piece



2017134

MR170
1 1/2"
45° × 45°
Ø52 × Ø40 × 7



2017135

MR122
1 1/8"
36° × 45°
Ø41 × Ø30,2 × 6,5



2017136

MR043
1 1/8"
36° × 36°
Ø41,5 × Ø30,15 × 6,5



2017137

MR121
1 1/8"
45° × 45°
Ø41,8 × Ø30,5 × 8



2017138

MR168
1 1/4"
45° × 45°
Ø46,8 × Ø34 × 7



2017139

MR151
1 3/8"
45° × 45°
Ø48,9 × Ø37 × 7



2017140

MR127
1 1/2"
36° × 45°
Ø51,8 × Ø40 × 8



2017141

MR019
1 1/2"
36° × 45°
Ø51,8 × Ø40 × 7,5



2017142

MR006
1 1/2"
36° × 36°
Ø51 × Ø40 × 6,5



2017143

MR171
1 1/2"
45° × 45°
Ø52 × Ø40 × 7,5



2017246

1 1/4"
45° × 45°
Ø46 × Ø34,1 × 7



2017247

1 1/8"
36° × 45°
Ø41 × Ø30,15 × 7



2019049

MR155
1 1/8"
45° × 45°
Ø41,8 × Ø30,5 × 7,7



2019050

MR137
1 1/4"
45° × 45°
Ø46,9 × Ø37 × 7



2019051

MR136
1 1/8"
45° × 45°
Ø41 × Ø30,15 × 7



2019052

1 1/4"
45° × 45°
Ø41,8 × Ø32,8 × 6



2019053

1 1/8"
36° × 45°
Ø41 × Ø30,15 × 7,7



2020048

1 1/8"
Ø41,8 × Ø30,2 × 6,5
45° × 45°



2020049

1 1/2"
45° × 45°
Ø52 × Ø40 × 6,5



2020050

1 3/8"
Ø44 × Ø35 × 5



2020051

1 3/8"
Ø48 × Ø37 × 7



ASSORTMENT BOX HEADSET PARTS

2020140

Assortment box headset parts



2020129

Fork cone for 1 1/8"
36° (silver)
Ø30 mm
1 pce



2020130

Fork cone for 1 1/8"
45° (black)
Ø30 mm
1 pce



2020131

Fork cone for 1 1/8"
36° (silver)
Ø33 mm
1 pce



2020132

Fork cone for 1 1/4"
45° (black)
Ø33 mm
1 pce



2020133

Fork cone for 1 1/2"
36° (silver)
Ø39,8 mm
1 pce



2020134

Fork cone for 1 1/2"
45° (black)
Ø39,8 mm
1 pce



2020122

Top cover for 1 1/8"
Ø46 mm
8,2 mm
1 pce



2020123

Top cover for 1 1/8"
Ø50 mm
7,2 mm
1 pce



2020124

Top cover for 1 1/8"
Ø55 mm
7,2 mm
1 pce



2020125

Compression ring for 1 1/8"
36° (silver)
5,8 mm
1 pce



2020126

Compression ring for 1 1/8"
45° (black)
5,8 mm
1 pce



2020127

Compression ring for 1 1/8"
36° (silver)
8,4 mm
1 pce



2020128

Compression ring for 1 1/8"
45° (black)
8,4 mm
1 pce



2017144-10

Micro spacer for 1 1/8"
Ø34,5 mm
0,25 mm
10 pcs



2020136

Spacer for 1 1/8"
Ø34,5 mm
2 mm
5 pcs



2020117

Top cap assembly
sphere shape
For 1 1/8" metal tube
Incl. bolt, star nut
and rubber sealing cap
5 pcs

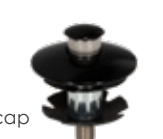

2020118

Top cap assembly
flat shape
For 1 1/8" metal tube
Incl. bolt and star nut
1 pce



2020119

Compression device
For 1 1/8" carbon tube
Incl. bolt, star
nut and rubber
sealing cap
1 pce



2020120

Compression device
For 1 1/8" carbon tube
Incl bolt and top cap
1 pce



2020121

Standard steel star nut
For 1 1/8" metal tube
5 pcs



2020135

Rubber sealing cap
For 5mm socket bolt
10 pcs



BRAKE

DISC BRAKE SYSTEMS
CALIPER ADAPTERS
DISC BRAKE ROTORS
DISC BRAKE PARTS
DISC BRAKE PADS
RIM BRAKE PADS

CABLE

INNER CABLES
OUTER CABLES
ATB/RACE CABLES
CABLE KITS
CABLE PARTS

HYDRO

ORIGINAL BRANDS
HYDRO COMPONENTS
SHIMANO HYDRO COMPONENTS
O-RINGS

ROTATION

BEARINGS
HEADSET BEARINGS
HEADSET PARTS
PULLEY WHEELS
BOTTOM BRACKET GUIDE
BOTTOM BRACKETS
BOTTOM BRACKET PARTS

TOOLS AND MAINTENANCE

MAINTENANCE
CABLE TOOLS
MORE TOOLS
HYDRO TOOLS
BOTTOM BRACKET TOOLS

WORKSHOP

TRANSIT
BOXER
PARTNER
CADDY
PADFINDER
DISCOVERY

PULLEY WHEELS

2 × 10 TEETH

CP2017231

ABEC 3 with extra grease

1 set

Stainless sealed bearing

Including spacers compatible with:

A - Shimano 8 speed

B - Shimano 7 speed, Campagnolo 8 speed

C - Campagnolo 9 / 10 speed

D - SRAM (one hole upper pulley) 9.0SL ('98) / 9.0 ('97 - '98) / 7.0 ('97 - '98) / 5.0 ('98 - '99)"



2 × 11 TEETH

CP2017086

ABEC 3 with extra grease

1 set

Stainless sealed bearing

Including spacers compatible with:

A - Shimano 8 / 9 / 10 / 11 speed

B - Shimano 7 speed, Campagnolo 8 speed

C - Campagnolo 9 / 10 speed

D - SRAM 7.0 / 9.0 ('97 - '99)"

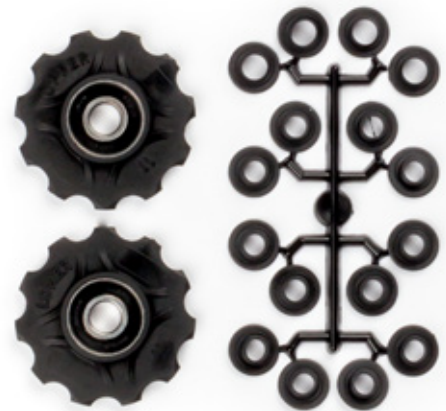

2 × 11 TEETH

2017086-BOX

ABEC 3 with extra grease

10 sets

Stainless sealed bearing

Including spacers compatible with:

A - Shimano 8 / 9 / 10 / 11 speed

B - Shimano 7 speed, Campagnolo 8 speed

C - Campagnolo 9 / 10 speed

D - SRAM 7.0 / 9.0 ('97 - '99)"



2 × 11 TEETH

CP2017100

ABEC 5 with extra grease
1 set
Stainless sealed bearing

Compatible with:
Shimano 9 / 10 / 11 speed
SRAM X0 / X9 / X7 9 speed MTB > 2011
SRAM X0 / X9 / X7 10 speed MTB
SRAM Apex / Rival / Force 10 speed road
(bushing included)
Campagnolo 11 speed



2 × 13 TEETH

CP2019103

ABEC 5 with extra grease
1 set
Stainless sealed bearing

Compatible with:
Shimano RD-M9100 / M8100 / M7100



BRAKE

DISC BRAKE SYSTEMS
CALIPER ADAPTERS
DISC BRAKE ROTORS
DISC BRAKE PARTS
DISC BRAKE PADS
RIM BRAKE PADS

CABLE

INNER CABLES
OUTER CABLES
ATB/RACE CABLES
CABLE KITS
CABLE PARTS

HYDRO

ORIGINAL BRANDS
HYDRO COMPONENTS
SHIMANO HYDRO COMPONENTS
O-RINGS

ROTATION

BEARINGS
HEADSET BEARINGS
HEADSET PARTS
PULLEY WHEELS
BOTTOM BRACKET GUIDE
BOTTOM BRACKETS
BOTTOM BRACKET PARTS

TOOLS AND MAINTENANCE

MAINTENANCE
CABLE TOOLS
MORE TOOLS
HYDRO TOOLS
BOTTOM BRACKET TOOLS

WORKSHOP

TRANSIT
BOXER
PARTNER
CADDY
PADFINDER
DISCOVERY

2 × 12 TEETH

CP2017101

ABEC 5 with extra grease
1 set
Narrow / wide
Stainless sealed bearing

Compatible with:
SRAM X01 / XX1 / X1 GX 1×11 speed
SRAM Rival 1 / Force 1 1×11 speed



12 + 14 TEETH

CP2017102

ABEC 5 with extra grease
1 set
Narrow / wide
Stainless sealed bearing

Compatible with:
SRAM Eagle XX1 / X01 / NX / SX / GX 1×12 speed
and 2×11 speed MTB



2 × 12 TEETH

2020097

ABEC 5 with extra grease
1 set
Narrow / wide
Ceramic hybrid bearing

Compatible with:
SRAM Force / Red eTap AXS



12 + 14 TEETH

2020098

ABEC 5 with extra grease
1 set
Narrow / wide
Ceramic hybrid bearing

Upgrade for:
SRAM Force / Red eTap AXS



BOTTOM BRACKET GUIDE —

A bottom bracket shell can be threaded or non-threaded, called thread fit and press fit respectively. It is important to know which type of shell you're working with and what the shell diameter and width are, in order to select a fitting bottom bracket.

The most common thread types in thread fit shells are BSA (English thread), ITA (Italian thread) and T47 (M47×1). A thread type bottom bracket is interlocked directly with the shell. Press fit shells come in various diameters and widths, most commonly PF30 (Ø46mm), BB30 (Ø42mm) and BB86/92 (Ø41mm). Press fit bottom brackets are pressed into the shell using a press-in tool.

Another dimension you need to know in order to select a fitting bottom bracket is the spindle

diameter. Different brands and models can vary widely, from Ø30mm to tapered versions like Praxis (Ø30mm – Ø28mm). Differences between brands can also be as little as a few hundreds of millimeters.

Elvedes offers a basic range of bottom brackets, which can be easily adapted to specific types of spindles such as FSA Mega Exo and SRAM / Truvativ GXP using specific bearing caps or reducer kits.

Elvedes also offers an enhanced version of the press fit bottom bracket, called the twist fit bottom bracket. The twist fit bottom bracket can alternatively be used in a press fit shell. Replacement bearings and bearing caps are also available for maintenance.

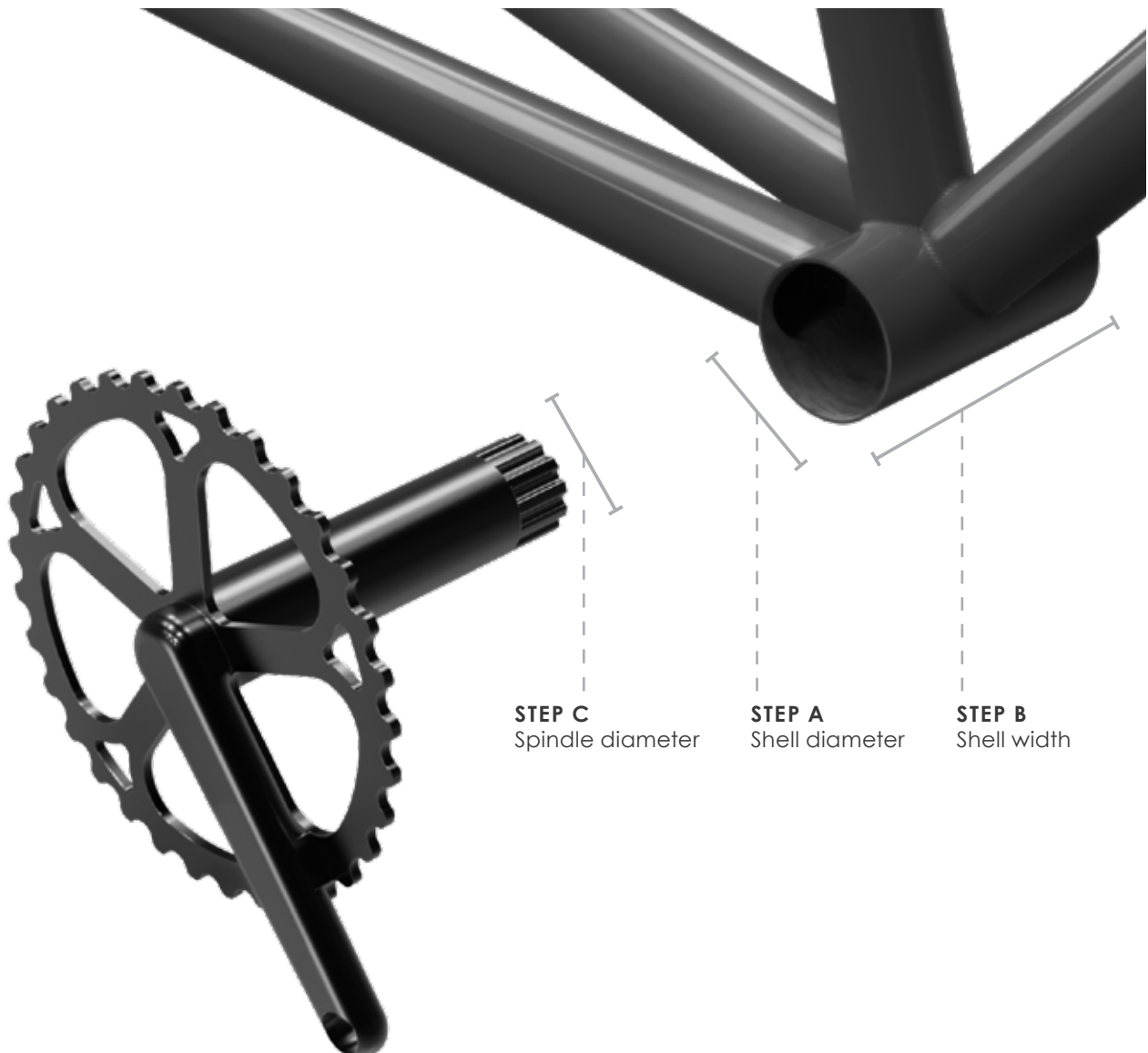

TWIST FIT —

ELVEDES ALWAYS STRIVES TO SUPPLY IN SOLUTIONS.

A common issue of the classic press fit bottom brackets is a squeaking and creaking sound because of a bad bearing alignment.

Press fit bottom brackets exist of three pieces which are independently pressed into the shell using a press-in tool. It often occurs that the left and right bearing are not 100% in line. This causes pressure on the bearings, wearing them out easily.

A solution to this problem is the Elvedes twist fit bottom bracket. This improved version of a press fit bottom bracket exists of two easily installed interlocking cups to create one rigid bracket in which the bearings are perfectly aligned. This makes sure the spindle can run without any sideways pressure, lifting both friction and creaking sounds.

The Elvedes CNC twist fit bottom brackets come in all sizes and can be used instead of regular press fit bottom brackets to bring your cycling experience to the next level. Once installed, the bearings can easily be replaced for maintenance while the bottom bracket stays in place. This saves a lot of time and keeps the costs low over time.

To assemble the Elvedes Twist Fit you will need the Elvedes Bottom Bracket Wrench (item no. 2018086 or the Elvedes Twist Fit Tool Kit (item no. 2018087)



— LOW MAINTENANCE COSTS

Only the bearings can be replaced for service maintenance, while the bracket stays in place.

— PERFECTLY IN LINE

The threaded interlocking cups allow the spindle to run freely without squeaking and creaking.

— EASY INSTALLATION

Elvedes BB wrench required (item no. 2018086)



Scan the QR code for an online manual for (dis)assembling Elvedes twist fit bottom brackets using Twist fit tool kit.



THREAD FIT BOTTOM BRACKETS

| Shell diameter Step A | Shell width Step B | Spindle diameter Step C | Bracket item no. | Additionally required* | Replacement bearing | Replacement bearing cap |
|-----------------------|--------------------|-----------------------------|------------------|------------------------|---------------------|-------------------------|
| BSA | 68 mm | 19 mm FSA Mega Exo | 2018065 | 2019064 | 2019087 | 2019064 |
| | | 22 - 24mm SRAM/Truvativ GXP | 2018065 | 2018080 | 2019087 | 2018083 |
| | | 24mm Shimano Road | 2018065 | | 2019087 | 2018081 |
| | | 19mm FSA Mega Exo | 2018066 | 2018064 | 2019087 | 2019064 |
| | 68 - 73 mm | 22 - 24mm SRAM/Truvativ GXP | 2018067 | | 2019087 | 2018081 |
| | | 24mm FSA Mega Exo | 2018066 | 2018083 | 2019087 | 2018083 |
| | | 24mm Shimano MTB | 2018066 | | 2019087 | 2018081 |
| | | 29mm SRAM DUB | 2019118 | | 2018077 | |
| | | 28mm - 30mm Praxis | 2020088 | | 2018077 | |
| | | 30mm IB30 | 2018068 | | 2018077 | |
| | 100 mm | 22 - 24mm SRAM/Truvativ GXP | 2019085 | 2018080 | 2019087 | 2018081 |
| | | 24mm Shimano Fatbike | 2019085 | | 2019087 | 2018081 |
| ITA | 70 mm | 19 mm FSA Mega Exo | 2018078 | 2019064 | 2019087 | 2019064 |
| | | 24mm FSA Mega Exo | 2018078 | 2018083 | 2019087 | 2018083 |
| | | 24mm Shimano Road | 2018078 | | 2019087 | 2018081 |
| | | 28mm - 30mm Praxis Road | 2020089 | | 2018077 | |
| | | 29mm SRAM DUB Road | 2019119 | | 2018077 | |
| | | 30mm IB30 | 2018079 | | 2018077 | |
| T47 | 68 mm | 24mm Shimano Ext | 2020093 | | 2019087 | |
| | | 28mm - 30mm Praxis Ext | 2020115 | | 2018077 | |
| | | 29mm SRAM DUB Ext | 2020111 | | 2018077 | |
| | 86 mm | 24mm Shimano Int Road | 2020092 | | 2019087 | |
| | | 28mm - 30mm Praxis Int Road | 2020114 | | 2018077 | |
| | | 29mm SRAM DUB Int Road | 2020112 | | 2018077 | |

Elvedes Twist fit tool kit (2018087) recommended. Elvedes Bottom bracket wrench (2018086) required.

* To fit certain spindles, an existing bottom bracket is used which can be adapted with an additional bearing cap set or reducer kit. The additional item is mentioned in the 'additionally required' column.

TWIST FIT BOTTOM BRACKETS

| SHELL DIAMETER STEP A | SHELL WIDTH STEP B | SPINDLE DIAMETER STEP C | BRACKET ITEM NO. | ADDITIONALLY REQUIRED* | REPLACEMENT BEARING | REPLACEMENT BEARING CAP |
|-----------------------|--------------------|-----------------------------|-------------------|------------------------|---------------------|-------------------------|
| Ø41mm | 86 mm | Campagnolo Ultra Torque | 2018070 | | 2019086 | |
| | 86 - 92 mm | 19mm FSA Mega Exo | 2018069 | 2019065 | 2019087 | 2019065 |
| | | 24mm FSA Mega Exo | 2018069 | 2018084 | 2019087 | 2018084 |
| | | 24mm Shimano | 2018069 | | 2019087 | 2018082 |
| | | 22 - 24mm SRAM/Truvativ GXP | 2019084 | 2018080 | 2019087 | 2018082 |
| | 106 -132mm | 24mm Shimano Fatbike | 2019084 | | 2019087 | 2018082 |
| | | 19mm FSA Mega Exo | 2018073 | 2019064 | 2019087 | 2019064 |
| Ø42mm | 68 - 73 mm | 22 - 24mm SRAM/Truvativ GXP | 2018073 | 2018080 | 2019087 | 2018081 |
| | | 24mm FSA Mega Exo | 2018073 | 2018083 | 2019087 | 2018083 |
| | | 24mm Shimano | 2018073 | | 2019087 | 2018081 |
| | | 28 - 30mm Praxis | 2020090 | | 2018077 | |
| | | 29mm SRAM DUB | 2019120 | | 2018077 | |
| Ø46mm | 68 mm | Campagnolo Ultra Torque | 2018074 | | 2019086 | |
| | 68 - 73 mm | 19mm FSA Mega Exo | 2018073 | 2019064 | 2018087 | 2019064 |
| | | 22 - 24mm SRAM/Truvativ GXP | 2018073 | 2018080 | 2018087 | 2018081 |
| | | 24mm FSA Mega Exo | 2018073 | 2018083 | 2018087 | 2018083 |
| | | 24mm Shimano | 2018073 | | 2018087 | 2018081 |
| | | 28 - 30mm Praxis | 2020090 | | 2018077 | |
| | | 29mm SRAM DUB | 2020120 | | 2018077 | |
| | 79 mm | 24mm Shimano | 2021065 | | 2018087 | 2018081 |
| | 86 - 92 mm | 19mm FSA Mega Exo | 2020084 | 2019064 | 2019087 | 2019064 |
| | | 22 - 24mm SRAM/Truvativ GXP | 2020084 | 2018080 | 2019087 | 2018081 |
| | | 24mm FSA Mega Exo | 2020084 | 2018083 | 2019087 | 2018083 |
| | | 24mm Shimano | 2020084 | | 2019087 | 2018081 |
| | | 28 - 30mm Praxis | 2020091 | | 2018077 | |
| | | 29mm SRAM DUB | 2019121 | | 2018077 | |
| | | 30mm BB386 | 2018071 | | 2018077 | |
| | | 100 mm | 30mm PF30 Fatbike | 2020086 | | 2018077 |

Elvedes Twist fit tool kit (2018087) recommended. Elvedes Bottom bracket wrench (2018086) required.

PRESS FIT BOTTOM BRACKETS

| SHELL DIAMETER STEP A | SHELL WIDTH STEP B | SPINDLE DIAMETER STEP C | BRACKET ITEM NO. | ADDITIONALLY REQUIRED* | REPLACEMENT BEARING | REPLACEMENT BEARING CAP |
|-----------------------|--------------------|-----------------------------|------------------|------------------------|---------------------|-------------------------|
| Ø41 mm | 86 - 92 mm | 19mm FSA Mega Exo | 2018064 | 2019065 | 2019087 | 2019065 |
| | | 22 - 24mm SRAM/Truvativ GXP | 2018064 | 2018080 | 2019087 | 2018082 |
| | | 24mm FSA Mega Exo | 2018064 | 2018084 | 2019087 | 2018084 |
| | | 24mm Shimano | 2018064 | | 2019087 | 2018082 |
| | | 28 - 30mm Praxis | 2020087 | | 2018077 | |
| | | 29mm SRAM DUB | 2019117 | | 2018077 | |
| | | 30mm IB30 | 2019117 | | 2018077 | |
| Ø42mm | 68 - 73 mm | 30mm BB30 | 2018077 | | 2018077 | |
| Ø46mm | 68 - 73 mm | 30mm PF30 | 2019083 | | 2018077 | |
| | 86 mm | 24mm Shimano | 2021079 | | 2018087 | 2018081 |

* To fit certain spindles, an existing bottom bracket is used which can be adapted with an additional bearingcap set or reducer kit. The additional item is mentioned in the 'additionally required' column.

BOTTOM BRACKETS

TWIST FIT

Tools required: 2018086 Bottom bracket wrench

- ¹ Convertible to GXP with GXP reducer kit (2018080)
- ² Convertible to FSA with FSA bearing caps (page 49)

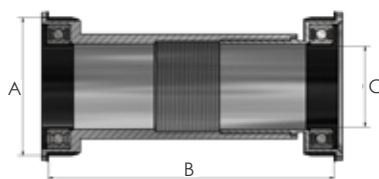

| | | A | B | C |
|---------|-------------------------|-------|--------------|------------------------------|
| 2018069 | BB86/92 Shimano | 41 mm | 86 - 92 mm | 24 mm Shimano ^{1 2} |
| 2018070 | BB86/92 UT | 41 mm | 86 mm | Campagnolo Ultra-Torque |
| 2018071 | BB386/392 | 46 mm | 86 - 92 mm | 30 mm |
| | PF30 | 46 mm | 68 - 73 mm | 30 mm |
| 2018073 | BB30 Shimano | 42 mm | 68 - 73 mm | 24 mm Shimano ^{1 2} |
| | PF30 Shimano | 46 mm | 68 - 73 mm | 24 mm Shimano ^{1 2} |
| 2018074 | PF30 UT | 46 mm | 68 mm | Campagnolo Ultra-Torque |
| 2019084 | Shimano Fatbike | 41 mm | 106 - 132 mm | 24 mm Shimano ¹ |
| | PF30 | 46 mm | 68 - 73 mm | 30 mm |
| 2019120 | BB30 | 42 mm | 68 - 73 mm | 30 mm |
| | PF30 DUB | 46 mm | 68 - 73 mm | 29 mm SRAM DUB |
| | BB30 DUB | 42 mm | 68 - 73 mm | 29 mm SRAM DUB |
| 2019121 | BB386 DUB | 46 mm | 86 mm | 29 mm SRAM DUB |
| 2020084 | BB386 Shimano | 46 mm | 86 mm | 24 mm Shimano ^{1 2} |
| 2020085 | BB386 UT | 46 mm | 86 mm | Campagnolo Ultra-Torque |
| 2020086 | PF30 Fatbike | 46 mm | 100 mm | 30 mm |
| | PF30 | 46 mm | 68 - 73 mm | 30 mm |
| 2020090 | BB30 | 42 mm | 68 - 73 mm | 30 mm |
| | PF30 Praxis | 46 mm | 68 - 73 mm | 28 - 30 mm Praxis M30 |
| | BB30 Praxis | 42 mm | 68 - 73 mm | 28 - 30 mm Praxis M30 |
| 2020091 | BB386 Praxis | 46 mm | 86 mm | 28 - 30 mm Praxis M30 |
| 2021065 | BB right (Cervélo only) | 46 mm | 79 mm | 24 mm Shimano |



PRESS FIT

- ¹ Convertible to GXP with GXP reducer kit (2018080)
- ² Convertible to FSA with FSA bearing caps (page 49)

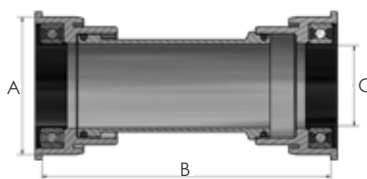

| | | A | B | C |
|---------|-----------------|-------|------------|------------------------------|
| 2019117 | BB86/92 DUB | 41 mm | 86 - 92 mm | 29 mm SRAM DUB |
| | BB86/92 | 41 mm | 86 - 92 mm | 30 mm |
| 2020087 | BB86/92 Praxis | 41 mm | 86 - 92 mm | 28 - 30 mm Praxis M30 |
| | BB86/92 | 41 mm | 86 - 92 mm | 30 mm |
| 2018064 | BB86/92 Shimano | 41 mm | 86 - 92 mm | 24 mm Shimano ^{1 2} |
| 2019083 | PF30 | 46 mm | 68 - 73 mm | 30 mm |
| 2021079 | BB386 | 46 mm | 86 mm | 24 mm Shimano |



THREAD FIT

Tools required: 2018086 Bottom bracket wrench

- ¹ Convertible to GXP with GXP reducer kit (2018080)
- ² Convertible to FSA with FSA bearing caps (page 49)

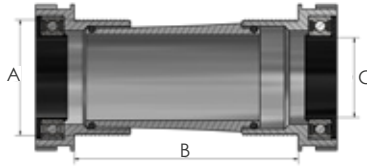

| | | A | B | C |
|---------|---------------------|-----|------------|--------------------------------|
| 2019118 | BSA DUB | BSA | 68 - 73 mm | 29 mm SRAM DUB |
| 2018067 | BSA GXP | BSA | 68 - 73 mm | 22 - 24 mm SRAM / Truvativ GXP |
| 2018068 | BSA IB30 | BSA | 68 - 73 mm | 30 mm |
| 2020088 | BSA Praxis | BSA | 68 - 73 mm | 28 - 30 mm Praxis M30 |
| 2019085 | BSA Shim Fatbike | BSA | 100 mm | 24 mm Shimano ¹ |
| 2018066 | BSA Shim MTB | BSA | 68 - 73 mm | 24 mm Shimano ² |
| 2018065 | BSA Shim Road | BSA | 68 mm | 24 mm Shimano ^{1,2} |
| 2019119 | ITA DUB | ITA | 70 mm | 29 mm SRAM DUB |
| 2018079 | ITA IB30 | ITA | 70 mm | 30 mm |
| 2020089 | ITA Praxis | ITA | 70 mm | 28 - 30 mm Praxis M30 |
| 2018078 | ITA Shim Road | ITA | 70 mm | 24 mm Shimano ² |
| 2020111 | T47 DUB External | T47 | 68 mm | 29 mm SRAM DUB |
| 2020112 | T47 DUB Internal | T47 | 86 mm | 29 mm SRAM DUB |
| 2020115 | T47 Praxis External | T47 | 68 mm | 28 - 30 mm Praxis M30 |
| 2020114 | T47 Praxis Internal | T47 | 86 mm | 28 - 30 mm Praxis M30 |
| 2020093 | T47 Shim External | T47 | 68 mm | 24 mm Shimano |
| 2020092 | T47 Shim Internal | T47 | 86 mm | 24 mm Shimano |



BRAKE

- DISC BRAKE SYSTEMS
- CALIPER ADAPTERS
- DISC BRAKE ROTORS
- DISC BRAKE PARTS
- DISC BRAKE PADS
- RIM BRAKE PADS

CABLE

- INNER CABLES
- OUTER CABLES
- ATB/RACE CABLES
- CABLE KITS
- CABLE PARTS

HYDRO

- ORIGINAL BRANDS
- HYDRO COMPONENTS
- SHIMANO HYDRO COMPONENTS
- O-RINGS

ROTATION

- BEARINGS
- HEADSET BEARINGS
- HEADSET PARTS
- PULLEY WHEELS
- BOTTOM BRACKET GUIDE
- BOTTOM BRACKETS
- BOTTOM BRACKET PARTS

TOOLS AND MAINTENANCE

- MAINTENANCE
- CABLE TOOLS
- MORE TOOLS
- HYDRO TOOLS
- BOTTOM BRACKET TOOLS

WORKSHOP

- TRANSIT
- BOXER
- PARTNER
- CADDY
- PADFINDER
- DISCOVERY

BEARING REPLACEMENT KIT

- ¹ Includes bearing caps for Shimano and FSA
- ² Convertible to GXP with GXP reducer kit (2018080)

| | |
|---------|----------------------------------|
| 2018077 | BB30 |
| 2018085 | BB90/95 Trek only ^{1,2} |
| 2019086 | Campagnolo Ultra - Torque |
| 2019087 | All Elvedes 24mm BB systems |



GXP REDUCER KIT

2018080
Reduces 24 mm to 22 mm GXP



BOTTOM BRACKET PARTS

ASSORTMENT BOX BOTTOM BRACKET SPACERS

2019070

Contains 157 pcs



2019071

Spacer ring

Plastic
Ø30 × Ø24 × 0,5 mm
20 pcs



2019072

Spacer ring

Plastic
Ø30 × Ø24 × 1 mm
20 pcs



2019073

Spacer ring

Plastic
Ø36 × Ø30 × 0,5 mm
20 pcs



2019074

Spacer ring

Plastic
Ø36 × Ø30 × 1 mm
20 pcs



2019075

Spacer ring

Aluminium
Ø38 × Ø30 × 2 mm
6 pcs



2019076

Spacer ring

Aluminium
Ø38 × Ø30 × 5 mm
4 pcs



2019077

Spacer ring

Aluminium
Ø38 × Ø30 × 7 mm
3 pcs



2019078

Spacer ring

Aluminium
Ø38 × Ø30 × 9 mm
2 pcs



2019079

Spacer ring

Aluminium
Ø38 × Ø30 × 11 mm
2 pcs



2019080

Wave washer

Aluminium
Ø31 × Ø22 × 0,3 mm
20 pcs



2019081

Wave washer

Aluminium
Ø31 × Ø24 × 0,6 mm
20 pcs



2019082

Wave washer

Aluminium
Ø40,5 × Ø32,8 × 0,3 mm
20 pcs



ASSORTMENT BOX BOTTOM BRACKET BEARING CAPS

2019056

2 pcs of every bearing cap
1 set GXP adapter



2018081

40 mm with edge

Shimano
Type A
2 pcs



2018082

37 mm without edge

Shimano
Type B
2 pcs



2018083

40 mm with edge

FSA
Type C
2 pcs



2018084

37 mm without edge

FSA
Type D
2 pcs



2019064

40 mm without edge

FSA 19 mm Mega Exo
Type E
2 pcs



2019065

37 mm without edge

FSA 19 mm Mega Exo
Type F
2 pcs



2019066

40 mm without edge

Shimano (fits Trek)
Type A0
2 pcs



2019067

40 mm without edge

FSA (fits Trek)
Type C0
2 pcs



2018080

GXP reducer kit
24 mm to 22 mm



BRAKE

DISC BRAKE SYSTEMS
CALIPER ADAPTERS
DISC BRAKE ROTORS
DISC BRAKE PARTS
DISC BRAKE PADS
RIM BRAKE PADS

CABLE

INNER CABLES
OUTER CABLES
ATB/RACE CABLES
CABLE KITS
CABLE PARTS

HYDRO

ORIGINAL BRANDS
HYDRO COMPONENTS
SHIMANO HYDRO COMPONENTS
O-RINGS

ROTATION

BEARINGS
HEADSET BEARINGS
HEADSET PARTS
PULLEY WHEELS
BOTTOM BRACKET GUIDE
BOTTOM BRACKETS
BOTTOM BRACKET PARTS

TOOLS AND MAINTENANCE

MAINTENANCE
CABLE TOOLS
MORE TOOLS
HYDRO TOOLS
BOTTOM BRACKET TOOLS

WORKSHOP

TRANSIT
BOXER
PARTNER
CADDY
PADFINDER
DISCOVERY

TOOLS AND MAINTENANCE



ETHANOL CLEANER

2018037
40/60
500 ml



ETHANOL CLEANER REFILL

2018089
40/60
500 ml



DISC CLEANER

2016020
500 ml



BRAKE

DISC BRAKE SYSTEMS
CALIPER ADAPTERS
DISC BRAKE ROTORS
DISC BRAKE PARTS
DISC BRAKE PADS
RIM BRAKE PADS

GREASE GUN

2019035
Labels included
Grease not included
80 ml



ORIGINAL NOZZLE

2020113
Short
Spare part



EXTENSION NOZZLE

2019036
Long
100mm



CABLE

INNER CABLES
OUTER CABLES
ATB/RACE CABLES
CABLE KITS
CABLE PARTS

HYDRO

ORIGINAL BRANDS
HYDRO COMPONENTS
SHIMANO HYDRO COMPONENTS
O-RINGS

ASSEMBLY PASTE

2020212
Refill for grease gun
White
Not for carbon parts
110 g



ROLLERBRAKE GREASE

2019038
Refill for grease gun
Black
110 g



LITHIUM GREASE

2019037
Refill for grease gun
Blue
110 g



ROTATION

BEARINGS
HEADSET BEARINGS
HEADSET PARTS
PULLEY WHEELS
BOTTOM BRACKET GUIDE
BOTTOM BRACKETS
BOTTOM BRACKET PARTS

MINERAL OIL BLUE

for all mineral systems

2016006 100 ml
2015170 250 ml
2020239 1 000 ml



MINERAL OIL RED

for all mineral systems

2016005 100 ml
2015169 250 ml
2020238 1 000 ml



DOT OIL

for all DOT systems

2015171 100 ml



TOOLS AND MAINTENANCE

MAINTENANCE
CABLE TOOLS
MORE TOOLS
HYDRO TOOLS
BOTTOM BRACKET TOOLS

WORKSHOP

TRANSIT
BOXER
PARTNER
CADDY
PADFINDER
DISCOVERY

CABLE TOOLS

CABLE PRICKER

2012029

Fits $\varnothing 4,1$ and $\varnothing 4,9$ mm outer cable



DEVELOPED BY 

CABLE CUTTER BASIC

2017070



CABLE CUTTER PROFESSIONAL

2009018
Felco C7



END CAP CRIMPING TOOL

2016093
For shift and brake end caps



FERRULE CRIMPING TOOL

2009019



INTERNAL CABLE GUIDER

2018057
Internal cable guider

Accessories included
For more liners see page 27



MECHANIC HEADLAMP

2019040

For perfect visibility during
internal cable guideing
and frame inspection

Beam adjustment
function

Batteries (4× AAA)
not included



O-RING / SEAL REMOVAL TOOL SET

2020202

Specially designed for easily
removing and replacing o-rings
and bearing seals



MULTI TOOL

2018026

Multi tool for disc brake and Centra-lock rings



ACCESSORIES REPLACEMENT SET

2019270

Magnetic pull wire



Pull wire



Magnet connector



DI2 connector



Cable and hose connector



Inner cable connector



PICK-UP MAGNET TOOL

2020096

For easily picking up internal
cables, steel bearing
balls and more

40 mm



INNER WIRE TENSION TOOL

2019041

For shift and brake inner wires



DISC ALIGNMENT TOOL

2019043



BRAKE

DISC BRAKE SYSTEMS

CALIPER ADAPTERS

DISC BRAKE ROTORS

DISC BRAKE PARTS

DISC BRAKE PADS

RIM BRAKE PADS

CABLE

INNER CABLES

OUTER CABLES

ATB/RACE CABLES

CABLE KITS

CABLE PARTS

HYDRO

ORIGINAL BRANDS

HYDRO
COMPONENTS

SHIMANO HYDRO
COMPONENTS

O-RINGS

ROTATION

BEARINGS

HEADSET BEARINGS

HEADSET PARTS

PULLEY WHEELS

BOTTOM BRACKET
GUIDE

BOTTOM BRACKETS

BOTTOM BRACKET
PARTS

TOOLS AND MAINTENANCE

MAINTENANCE

CABLE TOOLS

MORE TOOLS

HYDRO TOOLS

BOTTOM BRACKET
TOOLS

WORKSHOP

TRANSIT

BOXER

PARTNER

CADDY

PADFINDER

DISCOVERY

BLEEDING KIT

2012095

For mineral and DOT oil.
Incl. adapters for Shimano, Magura, Hayes, Avid / SRAM, Formula, Tektro and Elvedes



BLEED ADAPTER SET

2020095
Shimano



2020224
SRAM / Avid



2018043
Magura



2018047
Hayes



2018044
Tektro



2018048
Elvedes HP4000



2018045
Formula



OIL SYRINGES

2018040 Mineral oil syringes 2 pcs
2018041 DOT oil syringes 2 pcs



SNAP-ON CROWS FOOT 8 MM

2020094

For compression bolts (8 mm)

Fits 1/4" torque wrench



END PRESS

2017159

For fast and easily pressing inserts and banjos into hydraulic hose

Not suitable for Magura HS11/33

2018112
Spare insert driver

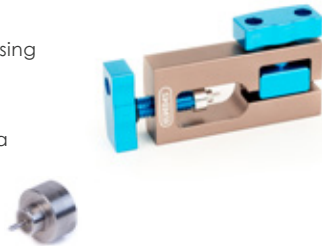

OPEN RING WRENCH 7 / 8

2017056

Specially designed for Shimano bleed bolt (7 mm)
For easy access to compression bolts (8 mm)



HOSE CUTTER BASIC

2019042

For smooth and burr-free cutted hydraulic hose
Prevents leakage and damage of the hose

For consumer use

Spare blade included inside



HOSE CUTTER PROFESSIONAL

2019124

For smooth and burr-free cutted hydraulic hose
Prevents leakage and damage of the hose

For professional use

2019232
Spare blade



TWIST FIT TOOL KIT

2018087

Tool kit to (dis)assemble all Elvedes twist fit, thread fit and SRAM DUB bottom brackets.

Dimensions casing:
36 × 27 × 7,5 cm



BEARING SERVICE KIT

2018088

Tool kit to (dis)assemble bottom bracket bearings

Dimensions casing:
22,5 × 11,5 × 4 cm



BOTTOM BRACKET WRENCH

2018086

Bottom bracket wrench for all Elvedes twist fit and thread fit systems

16 notch / 44 mm
12 notch / 48,5 mm



SRAM DUB TOOL ADAPTER

2019069

For Elvedes Twist fit and thread fit and original SRAM DUB



BRAKE

- DISC BRAKE SYSTEMS
- CALIPER ADAPTERS
- DISC BRAKE ROTORS
- DISC BRAKE PARTS
- DISC BRAKE PADS
- RIM BRAKE PADS

CABLE

- INNER CABLES
- OUTER CABLES
- ATB/RACE CABLES
- CABLE KITS
- CABLE PARTS

HYDRO

- ORIGINAL BRANDS
- HYDRO COMPONENTS
- SHIMANO HYDRO COMPONENTS
- O-RINGS

ROTATION

- BEARINGS
- HEADSET BEARINGS
- HEADSET PARTS
- PULLEY WHEELS
- BOTTOM BRACKET GUIDE
- BOTTOM BRACKETS
- BOTTOM BRACKET PARTS

TOOLS AND MAINTENANCE

- MAINTENANCE
- CABLE TOOLS
- MORE TOOLS
- HYDRO TOOLS
- BOTTOM BRACKET TOOLS

WORKSHOP

- TRANSIT
- BOXER
- PARTNER
- CADDY
- PADFINDER
- DISCOVERY

WORKSHOP



TRANSIT

2016042

No displays included

Dimensions
97x180x41 cm

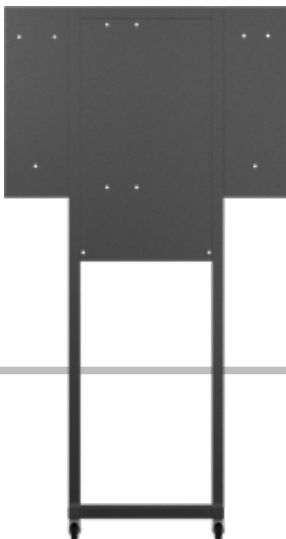

In order to increase efficiency in the workshop, Elvedes has developed a compact all-in-one mobile frame. This facilitates you to quickly and easily find all components you need for replacing cables and brake parts. No displays included. See page 74 - 79

5 full displays = Transit for free

BRAKE

- DISC BRAKE SYSTEMS
- CALIPER ADAPTERS
- DISC BRAKE ROTORS
- DISC BRAKE PARTS
- DISC BRAKE PADS
- RIM BRAKE PADS

CABLE

- INNER CABLES
- OUTER CABLES
- ATB/RACE CABLES
- CABLE KITS
- CABLE PARTS

HYDRO

- ORIGINAL BRANDS
- HYDRO COMPONENTS
- SHIMANO HYDRO COMPONENTS
- O-RINGS

ROTATION

- BEARINGS
- HEADSET BEARINGS
- HEADSET PARTS
- PULLEY WHEELS
- BOTTOM BRACKET GUIDE
- BOTTOM BRACKETS
- BOTTOM BRACKET PARTS

TOOLS AND MAINTENANCE

- MAINTENANCE
- CABLE TOOLS
- MORE TOOLS
- HYDRO TOOLS
- BOTTOM BRACKET TOOLS

WORKSHOP

- TRANSIT
- BOXER
- PARTNER
- CADDY
- PADFINDER
- DISCOVERY

BOXER

BOXER

2017027

Dimensions

53 x 36 x 36 cm
Fasteners included



Free choice of cable types!

3 volume boxes stainless inner cable
4 volume boxes outer cable
See page 25 + 27

Full display = display for free



PARTNER

2018115

Dimensions
53 x 14 x 7cm

Smart fix system



BRAKE

- DISC BRAKE SYSTEMS
- CALIPER ADAPTERS
- DISC BRAKE ROTORS
- DISC BRAKE PARTS
- DISC BRAKE PADS
- RIM BRAKE PADS

CABLE

- INNER CABLES
- OUTER CABLES
- ATB/RACE CABLES
- CABLE KITS
- CABLE PARTS

HYDRO

- ORIGINAL BRANDS
- HYDRO COMPONENTS
- SHIMANO HYDRO COMPONENTS
- O-RINGS

ROTATION

- BEARINGS
- HEADSET BEARINGS
- HEADSET PARTS
- PULLEY WHEELS
- BOTTOM BRACKET GUIDE
- BOTTOM BRACKETS
- BOTTOM BRACKET PARTS

TOOLS AND MAINTENANCE

- MAINTENANCE
- CABLE TOOLS
- MORE TOOLS
- HYDRO TOOLS
- BOTTOM BRACKET TOOLS

WORKSHOP

- TRANSIT
- BOXER
- PARTNER
- CADDY
- PADFINDER
- DISCOVERY

Free choice of cable parts!

10 jars
See page 34 - 38

Full display = display for free

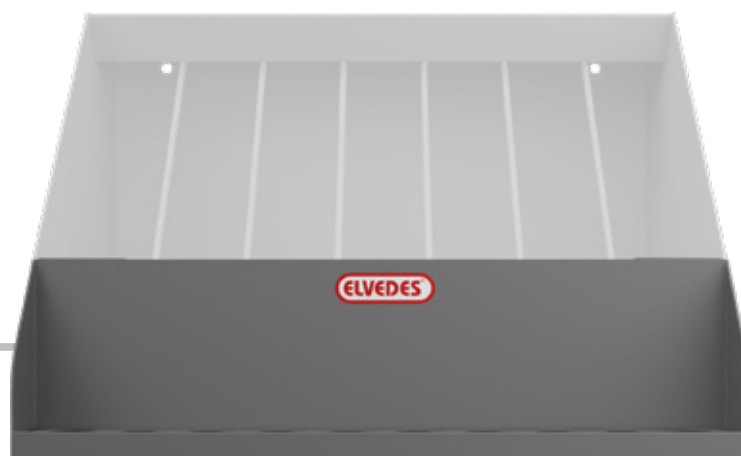

CADDY

2017091

Dimensions
19,5 x 65 x 12,5 cm

Fasteners included



Free choice of rim brake pads!

Choose 3 boxes with
25 pairs rim brake pads

See page 21-23

Full display = display for free

PADFINDER

2017024

Dimensions
13 x 65 x 12,5 cm

Fasteners included



Free choice of disc brake pads!

Choose 4 boxes with
10 pairs disc brake pads

See page 15-19

Full display = display for free

BRAKE

- DISC BRAKE SYSTEMS
- CALIPER ADAPTERS
- DISC BRAKE ROTORS
- DISC BRAKE PARTS
- DISC BRAKE PADS
- RIM BRAKE PADS

CABLE

- INNER CABLES
- OUTER CABLES
- ATB/RACE CABLES
- CABLE KITS
- CABLE PARTS

HYDRO

- ORIGINAL BRANDS
- HYDRO COMPONENTS
- SHIMANO HYDRO COMPONENTS
- O-RINGS

ROTATION

- BEARINGS
- HEADSET BEARINGS
- HEADSET PARTS
- PULLEY WHEELS
- BOTTOM BRACKET GUIDE
- BOTTOM BRACKETS
- BOTTOM BRACKET PARTS

TOOLS AND MAINTENANCE

- MAINTENANCE
- CABLE TOOLS
- MORE TOOLS
- HYDRO TOOLS
- BOTTOM BRACKET TOOLS

WORKSHOP

- TRANSIT
- BOXER
- PARTNER
- CADDY
- PADFINDER
- DISCOVERY



DISCOVERY STARTER KIT

2020045

pair of each disc brake pad in organic compound

The Discovery can be used in 3 different settings:

1. Swing display (use additional arm)
2. Wall display
3. Counter display (use additional bottom base)

Necessary parts and fasteners included

Dimensions
38 x 65,5 x 15 cm



Free choice of disc brake pads!

Choose 100 pairs disc brake pads to fill the Discovery

See page 15-19

Full display = display for free



DISCOVERY

2016074

The Discovery can be used in 3 different settings:

1. Swing display (use additional arm)
2. Wall display
3. Counter display (use additional bottom base)

Necessary parts and fasteners included

Dimensions
38 x 65,5 x 15 cm



BRAKE

- DISC BRAKE SYSTEMS
- CALIPER ADAPTERS
- DISC BRAKE ROTORS
- DISC BRAKE PARTS
- DISC BRAKE PADS
- RIM BRAKE PADS

CABLE

- INNER CABLES
- OUTER CABLES
- ATB/RACE CABLES
- CABLE KITS
- CABLE PARTS

HYDRO

- ORIGINAL BRANDS
- HYDRO COMPONENTS
- SHIMANO HYDRO COMPONENTS
- O-RINGS

ROTATION

- BEARINGS
- HEADSET BEARINGS
- HEADSET PARTS
- PULLEY WHEELS
- BOTTOM BRACKET GUIDE
- BOTTOM BRACKETS
- BOTTOM BRACKET PARTS

TOOLS AND MAINTENANCE

- MAINTENANCE
- CABLE TOOLS
- MORE TOOLS
- HYDRO TOOLS
- BOTTOM BRACKET TOOLS

WORKSHOP

- TRANSIT
- BOXER
- PARTNER
- CADDY
- PADFINDER
- DISCOVERY

Free choice of disc brake pads!

Choose 100 pairs disc brake pads to fill the Discovery

See page 15-19

Full display = display for free





Bike components.



**Elvedes
Youtube
Channel**
scan QR

Elvedes.com

info@elvedes.com
+31 (0)416 374 597

Visiting address

Grutter 7
NL-5253 RM Nieuwkuijk
The Netherlands

Item no. 2021091

