

PRODUCT CATALOG 2023





+ A LITTLE EXTRA

Plus, a word derived from Latin, meaning 'more'. Ever since Elvedes was founded, we have always been striving to do a little more. With the introduction of high steerers for mopeds in the sixties, the existing moped cables needed some more length. The demand caused Elvedes to add more different cables to the range, not only for mopeds and bicycles, but for all kinds of purposes, made to measure.

Through the years, more and more of bicycle service parts have been added to the range. Convenient displays for more overview and an organized workshop. Disc brake pads, but more than just the most common ones. Rim brake pads, but also with special compounds

which are more silent and more powerful. Twist fit bottom brackets, which not only add more stability to the bearings, but are also more durable because the bearings themselves can be replaced when worn. And many more.

We think that these smart additions and solutions would make the life of the mechanic or consumer just that little more convenient. To put these items to everyone's attention some more, we introduce the Elvedes + label, by which they can easily be recognized throughout this catalog. The label, along with a single highlighted sentence, explains why that particular item is such a big plus.



Elvedes +

This label can be found at different items throughout the catalog. It tells you why this particular item is such a big plus.



since 1965! —

Lourens van der Spruijt, founder of Elvedes, registered his own business with the Chamber of Commerce on February 8, 1965. He kept his stock of moped parts, such as cables, sprockets, chains and pistons, under his bed and in his car. For several years he visited bike shops directly to make sales. Especially the demand for cables was remarkably high, and caused Lourens to start assembling brake, throttle clutch and speedometer cables at his mother's kitchen table.

Elvedes changed from a moped parts trading company into a control cable manufacturer for mopeds and bicycles. Sales shifted from shops to wholesale partners, who took care of the distribution of the aftermarket cables.

In 2002 it was time for Lourens to put the business in the hands of his twin sons, Carl and Peter, who would have Elvedes grow with a large expansion of product groups into an internationally known brand within the 20 years to come.

By focusing on updating and innovating a complete range of quality products, yet keeping the company feel as the accessible family business it still is, Elvedes aims to be a brand that can be trusted to always be of full service.

INDEX —

04	BRAKE
05	DISC BRAKE SYSTEMS
07	CALIPER ADAPTERS
08	CALIPER BOLTS
09	DISC BRAKE ROTORS
12	DISC BRAKE PARTS
13	DISC BRAKE PADS
22	RIM BRAKE PADS
26	CABLE
27	INNER CABLES
30	OUTER CABLES
31	SUPERFLEX
32	CABLE KITS
36	CABLE PARTS
42	HYDRO
43	ORIGINAL BRANDS
46	HYDRO COMPONENTS
48	SHIMANO HYDRO COMPONENTS
49	O-RINGS
50	ROTATION
51	BEARINGS
54	HEADSET BEARINGS
58	HEADSET PARTS
59	PULLEY WHEELS
61	BOTTOM BRACKET GUIDE
65	BOTTOM BRACKETS
68	BOTTOM BRACKET PARTS
70	TOOLS AND MAINTENANCE
70	MAINTENANCE
71	CABLE TOOLS
72	HYDRO TOOLS
74	MORE TOOLS
75	BOTTOM BRACKET TOOLS
76	WORKSHOP
77	TRANSIT
78	BOXER
79	PARTNER
80	CADDY
81	PADFINDER
82	DISCOVERY

BRAKE



MP1000 MECHANICAL DISC BRAKE CALIPER

2017130

Post mount
1 pce

Dual piston disc brake caliper

For optimal performance, use with:
2010016 outer cable
1160 CNC ferrules
1,8 – 1,9mm rotor thickness

Replacement disc brake pads: 6894 model



MP1000 MECHANICAL DISC BRAKE CALIPER

2019097

Flat mount
1 pce

Dual piston disc brake caliper

For optimal performance, use with:
2010016 outer cable
1160 CNC ferrules
1,8 – 1,9mm rotor thickness

Replacement disc brake pads: 6907 model



MP1000 MECHANICAL DISC BRAKE CALIPER

2019098

Post mount TWIN
1 pair left + right

Dual piston disc brake caliper

For optimal performance, use with:
2010016 outer cable
1160 CNC ferrules
1,8 – 1,9mm rotor thickness

Replacement disc brake pads: 6894 model



Left

Right

MECHANICAL DISC BRAKE LEVER

2,5 - 3 finger

2017131	Left + right hand	1 pair
2018054	Left hand	1 pce
2018055	Right hand	1 pce



BRAKE

DISC BRAKE SYSTEMS

CALIPER ADAPTERS

CALIPER BOLTS

DISC BRAKE ROTORS

DISC BRAKE PARTS

DISC BRAKE PADS

RIM BRAKE PADS

CABLE

INNER CABLES

OUTER CABLES

SUPERFLEX

CABLE KITS

CABLE PARTS

HYDRO

ORIGINAL BRANDS

HYDRO
COMPONENTS

SHIMANO HYDRO
COMPONENTS

O-RINGS

ROTATION

BEARINGS

HEADSET BEARINGS

HEADSET PARTS

PULLEY WHEELS

BOTTOM BRACKET
GUIDE

BOTTOM BRACKETS

BOTTOM BRACKET
PARTS

TOOLS AND MAINTENANCE

MAINTENANCE

CABLE TOOLS

HYDRO TOOLS

MORE TOOLS

BOTTOM BRACKET
TOOLS

WORKSHOP

TRANSIT

BOXER

PARTNER

CADDY

PADFINDER

DISCOVERY

DISC BRAKE SYSTEMS

HP4000 HYDRAULIC DISC BRAKE SET

2017132

Mineral oil system
2,5 - 3 finger lever
Dual piston disc brake caliper

Replacement disc brake
pads for HP4000:
6890 model

Replacement
Ø160mm rotor: 2018053

Spare hose fitting set
for HP4000: CP2020139



Left hand - 1700mm

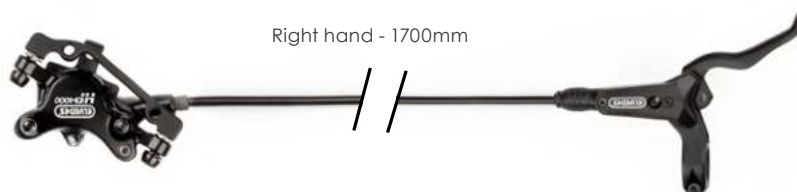

Right hand - 1700mm



HP4000 HYDRAULIC DISC BRAKE SET LEFT HAND

2018108



Left hand - 1700mm

HP4000 HYDRAULIC DISC BRAKE SET RIGHT HAND

2018107

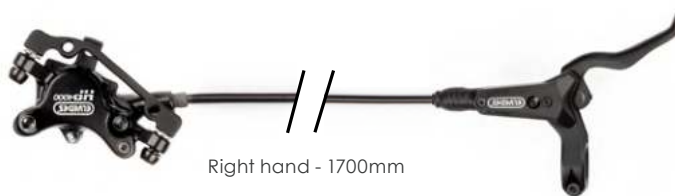

Right hand - 1700mm

HP4000 BLEED BLOCK

2022081



How to bleed
the HP4000
system



CALIPER ADAPTER

Adapter types are indicated caliper to frame
(e.g. PM-IS = PM caliper to IS frame/fork)
Bolts are included with every adapter



CP2017071

PM - IS
Ø160 front
Ø140 rear



CP2017072

PM - IS
Ø180 front
Ø160 rear



CP2015167

PM - IS
Ø180 rear



CP2015162

PM - IS
Ø203 front



CP2015168

PM - IS
Ø203 rear



CP2015158

PM - PM after 2013
Ø180



CP2016117

PM - PM after 2013
Ø140 → Ø160
Ø160 → Ø180



CP2015159

PM - PM
Ø160 → Ø203



CP2018058

PM - PM
Ø180 → Ø203



CP2022064

PM - PM
Ø160 → Ø220



CP2022065

PM - PM
Ø180 → Ø220



CP2022066

PM - PM
Ø203 → Ø220



CP2019046

FM - PM
Ø140 front



CP2019047

FM - PM
Ø140 rear



CP2019048

FM - PM
Ø140 front



CP2019045

FM - PM
Ø160 rear



CP2019044

FM - FM
Ø140 front
Ø160 front



CP2017160

FM - FM
Ø160 rear



BRAKE

DISC BRAKE SYSTEMS

CALIPER ADAPTERS

CALIPER BOLTS

DISC BRAKE ROTORS

DISC BRAKE PARTS

DISC BRAKE PADS

RIM BRAKE PADS

CABLE

INNER CABLES

OUTER CABLES

SUPERFLEX

CABLE KITS

CABLE PARTS

HYDRO

ORIGINAL BRANDS

HYDRO
COMPONENTS

SHIMANO HYDRO
COMPONENTS

O-RINGS

ROTATION

BEARINGS

HEADSET BEARINGS

HEADSET PARTS

PULLEY WHEELS

BOTTOM BRACKET
GUIDE

BOTTOM BRACKETS

BOTTOM BRACKET
PARTS

TOOLS AND MAINTENANCE

MAINTENANCE

CABLE TOOLS

HYDRO TOOLS

MORE TOOLS

BOTTOM BRACKET
TOOLS

WORKSHOP

TRANSIT

BOXER

PARTNER

CADDY

PADFINDER

DISCOVERY

CALIPER BOLTS

FLATMOUNT BOLTS FOR SHIMANO

2022052

M5 × 23mm
2 pieces



2022053

M5 × 28mm
2 pieces



2022054

M5 × 33mm
2 pieces



2022055

M5 × 38mm
2 pieces



2022056

M5 × 43mm
2 pieces



2022057

M5 × 48mm
2 pieces



FLATMOUNT BOLTS

2021113

M5 × 23mm
2 pieces



2021114

M5 × 28mm
2 pieces



2021115

M5 × 33mm
2 pieces



2021116

M5 × 38mm
2 pieces



2021117

M5 × 43mm
2 pieces



2021118

M5 × 48mm
2 pieces



2022021

FM adapter bolts
M5 × 8mm
2 pieces



2022020

Caliper bolts
M6 × 20mm
2 pieces



2022019

Caliper bolts
M6 × 35mm
M6 × 40mm
1 set



SC ROTOR

Stainless steel with aluminium Centra-lock

Thickness: 1,8mm

2020071	SC14	Ø140 mm	130 g
2020072	SC16	Ø160 mm	154 g
2020073	SC18	Ø180 mm	180 g
2020116	SC20	Ø203 mm	230 g



SX ROTOR

Stainless steel, 6 holes, including rotor bolts

Thickness: 1,8mm

2014069	SX14	Ø140 mm	86 g
6820	SX16	Ø160 mm	138 g
6821	SX18	Ø180 mm	151 g
2017092	SX20	Ø203 mm	188 g

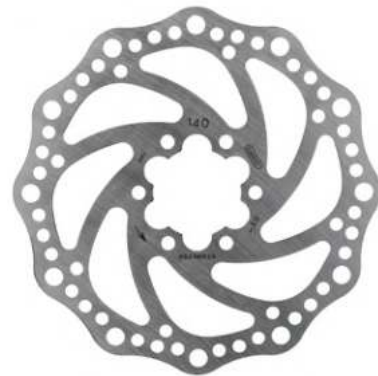

HP ROTOR

Stainless steel, 6 holes, including rotor bolts

Thickness: 1,8mm

2018053	HP16	Ø160 mm	96 g
2019057	HP18	Ø180 mm	127 g

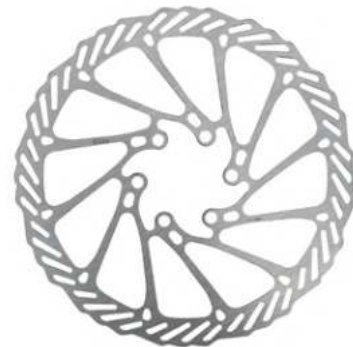

BMX ROTOR

Stainless steel, 6 holes, including rotor bolts

Thickness: 1,8mm

2019055	Ø120 mm
---------	---------



BRAKE

- DISC BRAKE SYSTEMS
- CALIPER ADAPTERS
- CALIPER BOLTS
- DISC BRAKE ROTORS
- DISC BRAKE PARTS
- DISC BRAKE PADS
- RIM BRAKE PADS

CABLE

- INNER CABLES
- OUTER CABLES
- SUPERFLEX
- CABLE KITS
- CABLE PARTS

HYDRO

- ORIGINAL BRANDS
- HYDRO COMPONENTS
- SHIMANO HYDRO COMPONENTS
- O-RINGS

ROTATION

- BEARINGS
- HEADSET BEARINGS
- HEADSET PARTS
- PULLEY WHEELS
- BOTTOM BRACKET GUIDE
- BOTTOM BRACKETS
- BOTTOM BRACKET PARTS

TOOLS AND MAINTENANCE

- MAINTENANCE
- CABLE TOOLS
- HYDRO TOOLS
- MORE TOOLS
- BOTTOM BRACKET TOOLS

WORKSHOP

- TRANSIT
- BOXER
- PARTNER
- CADDY
- PADFINDER
- DISCOVERY

DISC BRAKE ROTORS

LX16 LIGHT WEIGHT ROTOR

Stainless steel, 6 holes, including rotor bolts

Thickness: 1,8mm

2015194	Black	Ø160 mm	85 g
2015195	Blue	Ø160 mm	85 g
2015196	Red	Ø160 mm	85 g
2021066	Stainless	Ø160 mm	85 g



LX18 LIGHT WEIGHT ROTOR

Stainless steel, 6 holes, including rotor bolts

Thickness: 1,8mm

2015197	Black	Ø180 mm	112 g
2015198	Blue	Ø180 mm	112 g
2015199	Red	Ø180 mm	112 g
2021067	Stainless	Ø180 mm	112 g



RX FLOATING ROTOR

Stainless steel and aluminium, 6 holes, including rotor bolts

Thickness: 1,8mm

2015152	RX14	Ø140 mm	96 g
2015206	RX16	Ø160 mm	120 g
2015207	RX18	Ø180 mm	148 g
2015208	RX20	Ø203 mm	196 g



FX16 FLOATING ROTOR

Stainless steel and aluminium, 6 holes, including rotor bolts

Thickness: 1,8mm

2015146	Black	Ø160 mm	108 g
2015147	Blue	Ø160 mm	108 g
2015148	Red	Ø160 mm	108 g

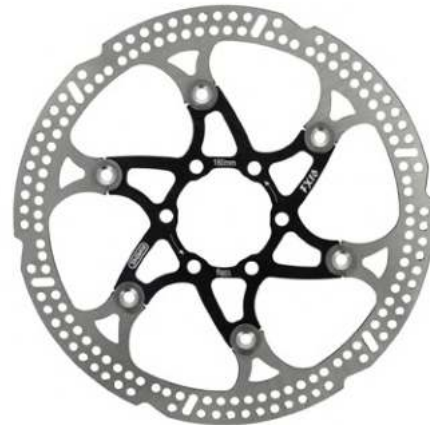
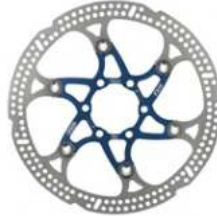
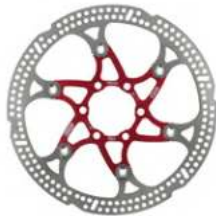

FX18 FLOATING ROTOR

Stainless steel and aluminium, 6 holes, including rotor bolts

Thickness: 1,8mm

2015149	Black	Ø180 mm	132 g
2015150	Blue	Ø180 mm	132 g
2015151	Red	Ø180 mm	132 g



CRX COOLING ROTOR

Stainless steel and aluminium, 6 holes, including rotor bolts

Thickness: 1,8mm

2017162	CRX14	Ø140 mm	101 g
2017163	CRX16	Ø160 mm	127 g
2017164	CRX18	Ø180 mm	152 g



BRAKE

- DISC BRAKE SYSTEMS
- CALIPER ADAPTERS
- CALIPER BOLTS
- DISC BRAKE ROTORS
- DISC BRAKE PARTS
- DISC BRAKE PADS
- RIM BRAKE PADS

CABLE

- INNER CABLES
- OUTER CABLES
- SUPERFLEX
- CABLE KITS
- CABLE PARTS

HYDRO

- ORIGINAL BRANDS
- HYDRO COMPONENTS
- SHIMANO HYDRO COMPONENTS
- O-RINGS

ROTATION

- BEARINGS
- HEADSET BEARINGS
- HEADSET PARTS
- PULLEY WHEELS
- BOTTOM BRACKET GUIDE
- BOTTOM BRACKETS
- BOTTOM BRACKET PARTS

TOOLS AND MAINTENANCE

- MAINTENANCE
- CABLE TOOLS
- HYDRO TOOLS
- MORE TOOLS
- BOTTOM BRACKET TOOLS

WORKSHOP

- TRANSIT
- BOXER
- PARTNER
- CADDY
- PADFINDER
- DISCOVERY

DISC BRAKE PARTS

ROTOR ACCESSORIES

CP2012048

CNC Centra-lock
Adapter with lock ring
Aluminium
1 pce



2021068

CNC Centra-lock
Lock ring
Aluminium
1 pce



2019068

Rotor shim
0,1 mm
Stainless steel
8 pcs



2019054

Rotor shim
0,2 mm
Stainless steel
8 pcs



2017149

Rotor shim
1,0 mm
Stainless steel
1 pce



CP2015153

Rotor bolt
Torx head
Titanium CNC
6 pcs



2017187

Rotor bolt
Torx head
Stainless steel
12 pcs



ELV2015157

Rotor bolt
Torx head
Stainless steel
100 pcs



PINS AND CLIPS

2017178

Set screw
Magura Marta,
Gustava, Louise
2007
M4×22,5
10 pcs



2017179

Fixing pin
Shimano Deore,
Avid Elixir 1/3
35mm
10 pcs



2017180

Fixing pin
Hayes, Hope
45mm
10 pcs



2017181

Fixing bolt
Avid Elixir 5/7/9,
Guide, Code, Trail
M4×22
10 pcs



2017182

Fixing bolt
Shimano XT, XTR,
Magura MT 2/4/6/8,
Tektro, Formula Oro
M4×27
10 pcs



2017183

Fixing bolt
Hayes Ryde,
Dyno
M4×36
10 pcs



2017184

Fixing bolt
Formula Mega,
Hope E4/V4/
X2/V2
M5×25
10 pcs



2020247

Clip
M4/M5
10 pcs



2020248

Clip
SRAM
10 pcs



DISC BRAKE PAD GUIDE

HOW TO EXTEND THE LIFETIME OF YOUR DISC BRAKE PADS

Bed-in disc brake pads extend the life span of the pads considerably! Squeeze them in carefully and ensure that the pad just audibly touches the brake disc for approximately 100 metres at a speed of ± 25 km/hour. Now squeeze a little harder on the brake so that the speed decreases to approximately 5 km/hour, and then slowly increase the speed while gently squeezing the brake. Repeat this 10-12 times and the pads are worn in. Never brake to a stop with the brake still squeezed in order to prevent damage to the rotor. Always bed-in the front and rear brakes separately.

WHY ELVEDES DISC BRAKE PADS?

Elvedes believes that offering 3 different compounds can satisfy all riders in different circumstances with different bikes. Our compounds are compatible with all brands and types of stainless steel rotors on the market and will give you the brake power you will need. In the overview below, the performance of each compound is simply explained to easily make the right choice of disc brake pads.

ORGANIC (RESIN) COMPOUND

Excellent for gravel bikes, racing bikes and trekking bikes



METALLIC CARBON (SEMI-METAL) COMPOUND

Excellent for E-bikes, cargo bikes and delivery bikes

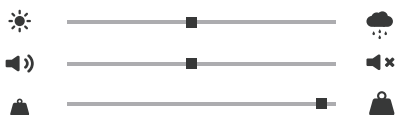

SINTERED (METAL) COMPOUND

Excellent for mountain bikes



ORDER QUANTITY

All organic, sintered and metallic carbon disc brake pads have a steel backplate.

XXXX -CARD

All disc brake pads can be ordered per card, containing 1 pair.

Necessary pins and clips included with all types of disc brake pads on card.

Fits Discovery display (page 82 - 83)



XXXX -BOX

Selected disc brake pads can be ordered per box, containing 10 pairs

Fits Padfinder display (page 81)



XXXX -BOX25

Selected disc brake pads can be ordered per box, containing 25 pairs.

Fits Padfinder display (page 81)



BRAND	MODEL	ORGANIC	SINTERED	METALLIC CARBON
Alhonga	SNG mechanical	6872		6872MC
Assess	C420, C425, C470 C430	6886 6881		6886MC
Avid	BB3, BB5 BB7, Juicy Code, Code 5 Code > 2011 DB1, DB3 Elixir X0, X7, X9 Trail	6886 6855 6882 6895 6906 6890 6898	6855S 6895S 6906S 6890S 6898S	6886MC 6855MC 6895MC 6906MC 6890MC 6898MC
Campagnolo		6908		
Cannondale	Coda	6865		
Clarks	Clout 1, S2 M1, M2, M3, CMD-22(FM), CMD-23, CMD-27 M4 Exo, Skeletal CMD-24, HDB-540, HDB-600, HDB-790 CMD-9, CMD-17(R) CMD-15	6854 6894 6891 6860 6859 6886 6855	6854S 6894S 6891S 6859S	6854MC 6894MC 6891MC 6886MC 6855MC
Diatech	Anchor Twincam	6880 6864		
Elvedes	HP4000 MP1000 PM MP1000 FM	6890 6894 6907	6890S 6894S 6907S	6890MC 6894MC 6907MC
Formula	4-Racing, B4 Team C1, Cura, Cura-E, Mega, R1(R), RO(R), RX, The One Cura 4 Extreme hydraulic Oro	6869 6893 6909 6869 6867 6863	6893S 6893S 6909S 6863S	6893MC 6909MC
Giant	MPH 2000 MPH 2001 - 2003, MPH-2, MPH-3 Root	6852 6861 6854	6854S	6854MC
Grimeca	System 8, 12, 16 System 13	6853 6869		
Hayes	Dominion A4 Dyno, Stroker Ryde El Camino HFX, MX 1 Prime Stroker Ace Stroker Carbon, Gram, Trail, GX2 MX2, MX3, MX4, Sole	6910 6888 6885 6850 6896 6892 6889 6862	6910S 6888S 6850S 6896S 6889S	6910MC 6862MC
Hope	C2, O2 DH4, M4 2002 E4, RX4-SH Mini Mono 6 2007, 6-Ti 2004, Moto M6 Mono M4 Mono Mini Mono Trial, Trial Zone V2 V4 X2 XC4	6852 6871 6903 6870 6876 6853 6877 6887 6883 6899 6911 6873	6899S 6911S	6911MC
Logan		6874		
Magura	Clara 2000 - 2001, Louise 1999 - 2001 Clara 2001 - 2002, Louise (FR) 2002 - 2006 Gustav M 2000 - 2011 Julie 2001 - 2008 Julie HP, Louise > 2007, Louise Bat, Louise Carbon, Marta > 2009 Marta 2002 - 2008, Marat SL 2003 - 2008 MT2, MT4, MT6, MT8, MT Sport MT5, MT7	6851 6857 6878 6856 6884 6860 6897 6902 6904	6884S	6897MC 6902MC
Promax	DC320, 610, 610J, 700, DSK400, 601J, Xnine DC600 DC710, 720, 913, Decipher, DSK-300(R), 310, 330R, 715, Render (R) DC901, 951 DC905, 907, 908, DSK-950 DC910 Decode R DSK-718R, DSK-909, E-Capsule, F1, Lucid, Solve DSK-810 Lucid P4	6879 6850 6886 6880 6855 6851 6854 6862 6853	6850S 6855S	6886MC 6855MC 6854MC 6862MC
Quad	QHD-1	6854	6854S	6854MC
RST	D-Power mechanical	6854 6866	6854S	6854MC

DISC BRAKE PADS

BRAND	MODEL	ORGANIC	SINTERED	METALLIC CARBON
Shimano	105 BR-R7070, BR-RS505	6907	6907S	6907MC
	Acera BR-M3060	6854	6854S	6854MC
	Alfine BR-S500, 501	6859	6859S	
	Alfine BR-S700	6894	6894S	6894MC
	Alivio BR-M395, 4050	6854	6854S	6854MC
	Altus BR-M315, 365, 375	6854	6854S	6854MC
	BR-CX75, BR-R315, 517	6894	6894S	6894MC
	BR-M355, 415, 416, 416A, 445, 447, 465, 475, 485, 486, 495, 575	6854	6854S	6854MC
	BR-M545, BR-R505, BR-T605	6859	6859S	
	BR-MT520	6891	6891S	6891MC
	BR-RS305	6907	6907S	6907MC
	Deore BR-M515, 515LA, 525, BR-T 615	6854	6854S	6854MC
	Deore BR-M535, 595, 596	6859	6859S	
	Deore BR-M555, 555-M	6858		
	Deore BR-M615, BR-R785, BR-RS785	6894	6894S	6894MC
	Deore LX BR-M585, BR-T665	6859	6859S	
	Deore LX BR-TX805	6854	6854S	6854MC
	Deore XT BR-M755, 755-DH	6853		
	Deore XT BR-M765, 775, 776	6859	6859S	
	Deore XT BR-M785, 8000	6894	6894S	6894MC
	Deore XT BR-M8020	6891	6891S	6891MC
	Dura-ace BR-R9170	6907	6907S	6907MC
	Hone BR-M601	6859	6859S	
	Metrea BR-U5000	6907	6907S	6907MC
	Nexave BR-C501, 601	6854	6854S	6854MC
	Nexave BR-C901	6858		
	Saint BR-M800	6859	6859S	
	Saint BR-M810, 820	6891	6891S	6891MC
	SLX BR-M665	6859	6859S	
	SLX BR-M666, 675, 7000	6894	6894S	6894MC
	Sora BR-R317	6894	6894S	w6894MC
	Tiagra BR-RS405	6907	6907S	6907MC
Tourney BR-C901	6854	6854S	6854MC	
Ultegra BR-CX77	6894	6894S	6894MC	
Ultegra BR-R8070, BR-RS805	6907	6907S	6907MC	
XTR BR-M9000, 9020, 985, 987	6894	6894S	6894MC	
XTR BR-M9100	6907	6907S	6907MC	
XTR BR-M9120	6891	6891S	6891MC	
XTR BR-M965, 966, 975	6859	6859S		
ZEE BR-M640	6891	6891S	6891MC	
SRAM	700 B1 HRD, Apex, CX1, eTap, Force, HRR, Level TLM, Level Ultimate, Red, Rival, S900	6900	6900S	6900MC
	9.0	6853		
	Code, Guide RE	6895	6895S	6895MC
	DB5, Level, Level T, Level TL, Force eTap, Rival eTap, RED two-piece caliper	6906	6906S	6906MC
	Guide R, Guide RS, Guide RSC, Guide Ultimate	6898	6898S	6898MC
Via GT, X0, XX, XX World Cup	6890	6890S	6890MC	
Suntour	DB XCC-MC	6875		
	SR1	6879		
Tekro	Aquila MD-M500	6854	6854S	6854MC
	Aries MD-M300	6854	6854S	6854MC
	Auriga E HD-E500, 520, 525, 530	6854	6854S	6854MC
	Auriga HD-E515, HD-T515, Auriga E HD-E510	6875		
	Auriga HD-M290, 291 HD-T520, 525, 530, Auriga Pro HD-M700	6854	6854S	6854MC
	Dorado 4P HD-E720, 725, HD-M745	6891	6891S	6891MC
	Dorado HD-E710	6905		
	Dorado HD-E715	6854	6854S	6854MC
	Draco HD-M350, 351, 352	6854	6854S	6854MC
	Gemini HD-M500, 501, 510, 520, 521	6854	6854S	6854MC
	HDC HD-M300, 301, 330	6854	6854S	6854MC
	HD-E350, HD-T285, MD-C510, MD-M280, MD-U510	6854	6854S	6854MC
	HD-R310, 510	6907	6907S	6907MC
	IO	6868		
	Junior HD-M282	6854	6854S	6854MC
	Lyra	6901		
	Mira MD-C400	6854	6854S	6854MC
	Orion 4+2P (front) HD-M735, Orion 4P HD-M745	6891	6891S	6891MC
Orion HD-M720, 730, Orion 4+2P (rear) HD-M735, Orion SL HD-M740	6854	6854S	6854MC	
Vela HD-T290	6854	6854S	6854MC	
Volans HD-T700	6875			
Volans HD-T710	6854	6854S	6854MC	
TRP	Dash Sport, HY/RD, Hylex, Hylex RS HD-C801, Parabox R, Slate X2, Spyke, Spyre	6854	6854S	6854MC
	G-Spec, Quadiem, Slate T4, Zurich	6891	6891S	6891MC
	Hylex HD-C810, Hylex RS HD-C811, HD-T910	6907	6907S	6907MC
VanMoof	Model S	6862		6862MC
	Model X	6862		6862MC
Zoom		6872		6872MC

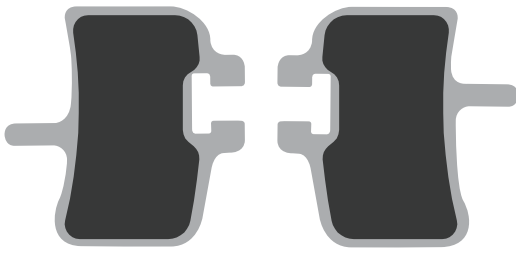

6850 - CARD
6850 S - CARD

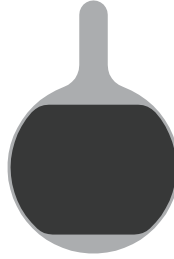

6851 - CARD

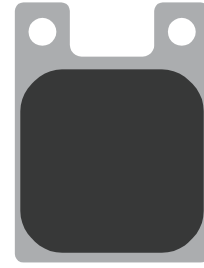

6852 - CARD

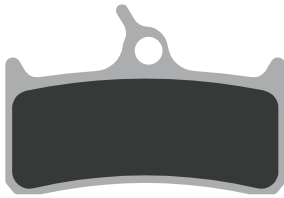

6853 - CARD

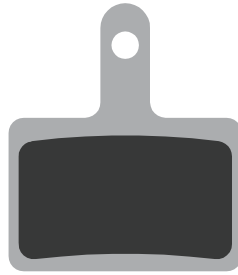

6854 - CARD / -BOX / -BOX25
6854 S - CARD / -BOX / -BOX25
6854 MC - CARD / -BOX / -BOX25

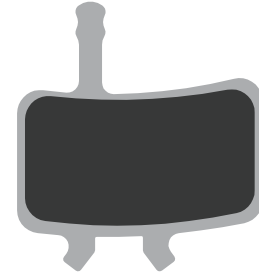

6855 - CARD
6855 S - CARD
6855 MC - CARD

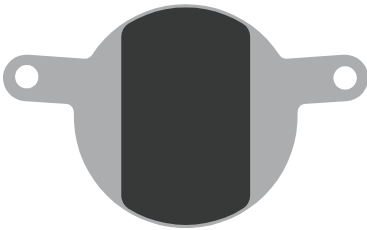

6856 - CARD



6857 - CARD

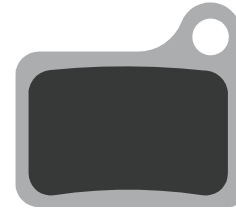

6858 - CARD



6859 - CARD
6859 S - CARD



6860 - CARD

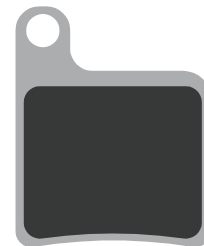

6861 - CARD

BRAKE

- DISC BRAKE SYSTEMS
- CALIPER ADAPTERS
- CALIPER BOLTS
- DISC BRAKE ROTORS
- DISC BRAKE PARTS
- DISC BRAKE PADS
- RIM BRAKE PADS

CABLE

- INNER CABLES
- OUTER CABLES
- SUPERFLEX
- CABLE KITS
- CABLE PARTS

HYDRO

- ORIGINAL BRANDS
- HYDRO COMPONENTS
- SHIMANO HYDRO COMPONENTS
- O-RINGS

ROTATION

- BEARINGS
- HEADSET BEARINGS
- HEADSET PARTS
- PULLEY WHEELS
- BOTTOM BRACKET GUIDE
- BOTTOM BRACKETS
- BOTTOM BRACKET PARTS

TOOLS AND MAINTENANCE

- MAINTENANCE
- CABLE TOOLS
- HYDRO TOOLS
- MORE TOOLS
- BOTTOM BRACKET TOOLS

WORKSHOP

- TRANSIT
- BOXER
- PARTNER
- CADDY
- PADFINDER
- DISCOVERY

DISC BRAKE PADS



6862 - CARD
6862 MC - CARD

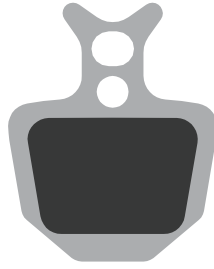

6863 - CARD
6863 S - CARD



6864 - CARD



6865 - CARD

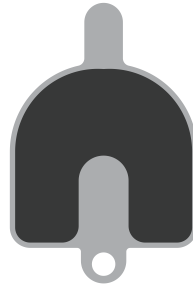

6866 - CARD



6867 - CARD

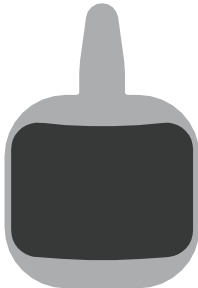

6868 - CARD



6869 - CARD

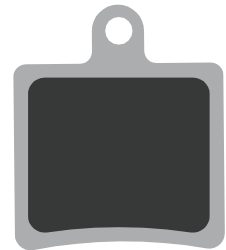

6870 - CARD

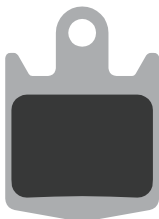

6871 - CARD



6872 - CARD
6872 MC - CARD

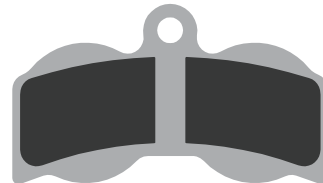

6873 - CARD



6874 - CARD

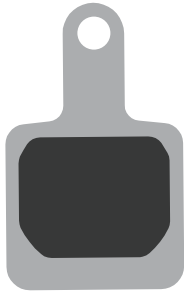

6875 - CARD

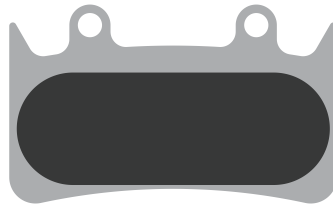

6876 - CARD

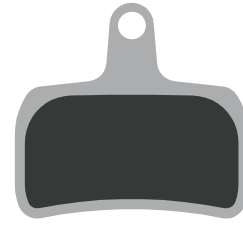

6877 - CARD

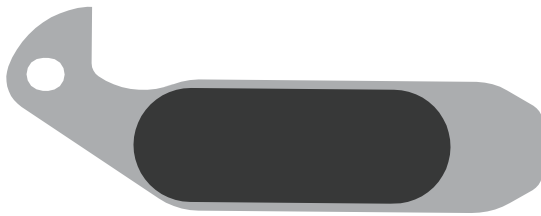

6878 - CARD



6879 - CARD

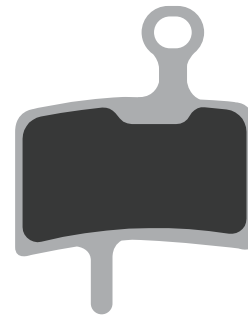

6880 - CARD



6881 - CARD

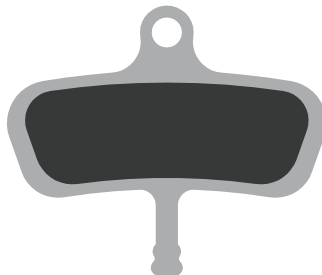

6882 - CARD

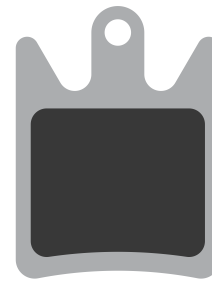

6883 - CARD

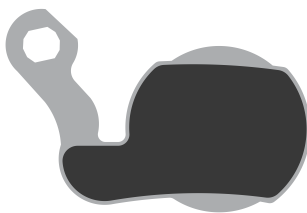

6884 - CARD
6884 S - CARD



6885 - CARD



6886 - CARD
6886 MC - CARD

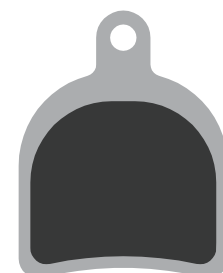

6887 - CARD

BRAKE

- DISC BRAKE SYSTEMS
- CALIPER ADAPTERS
- CALIPER BOLTS
- DISC BRAKE ROTORS
- DISC BRAKE PARTS
- DISC BRAKE PADS
- RIM BRAKE PADS

CABLE

- INNER CABLES
- OUTER CABLES
- SUPERFLEX
- CABLE KITS
- CABLE PARTS

HYDRO

- ORIGINAL BRANDS
- HYDRO COMPONENTS
- SHIMANO HYDRO COMPONENTS
- O-RINGS

ROTATION

- BEARINGS
- HEADSET BEARINGS
- HEADSET PARTS
- PULLEY WHEELS
- BOTTOM BRACKET GUIDE
- BOTTOM BRACKETS
- BOTTOM BRACKET PARTS

TOOLS AND MAINTENANCE

- MAINTENANCE
- CABLE TOOLS
- HYDRO TOOLS
- MORE TOOLS
- BOTTOM BRACKET TOOLS

WORKSHOP

- TRANSIT
- BOXER
- PARTNER
- CADDY
- PADFINDER
- DISCOVERY

DISC BRAKE PADS

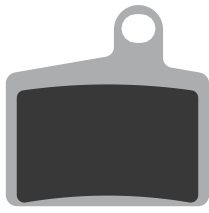

6888 - CARD
6888 S - CARD

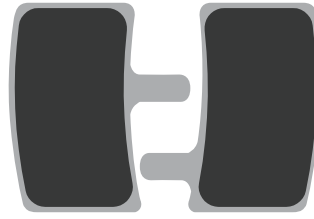

6889 - CARD
6889 S - CARD

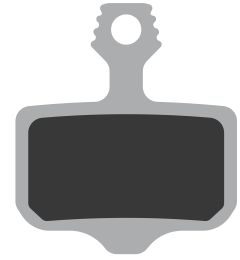

6890 - CARD / -BOX
6890 S - CARD / -BOX
6890 MC - CARD / -BOX

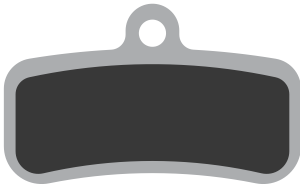

6891 - CARD
6891 S - CARD
6891 MC - CARD



6892 - CARD

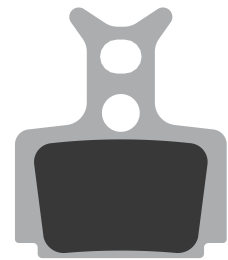

6893 - CARD
6893 S - CARD
6893 MC - CARD

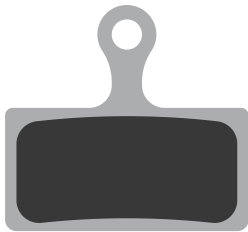

6894 - CARD / -BOX / -BOX25
6894 S - CARD / -BOX / -BOX25
6894 MC - CARD / -BOX / -BOX25

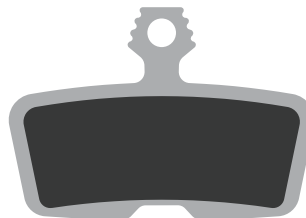

6895 - CARD
6895 S - CARD
6895 MC - CARD



6896 - CARD
6896 S - CARD

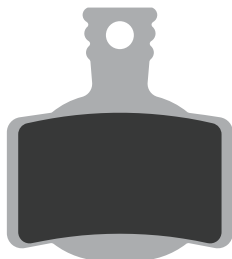

6897 - CARD / -BOX
6897 S - CARD / -BOX
6897 MC - CARD / -BOX



6898 - CARD / -BOX
6898 S - CARD / -BOX
6898 MC - CARD / -BOX

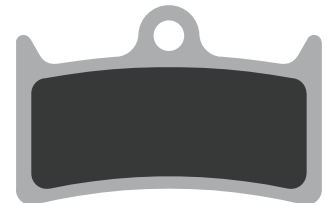

6899 - CARD
6899 S - CARD

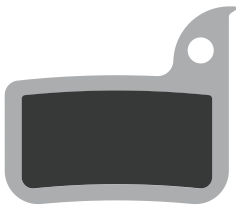

6900 - CARD / -BOX / -BOX25
 6900 S - CARD / -BOX / -BOX25
 6900 MC - CARD / -BOX / -BOX25

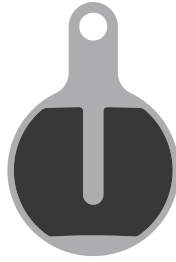

6901 - CARD

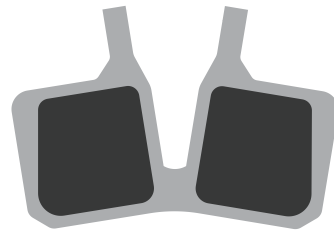

6902 - CARD / -BOX / -BOX25
 6902 S - CARD / -BOX / -BOX25
 6902 MC - CARD / -BOX / -BOX25

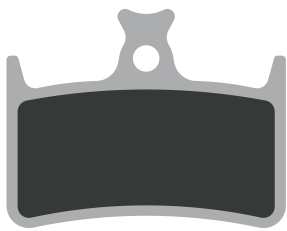

6903 - CARD



6904 - CARD

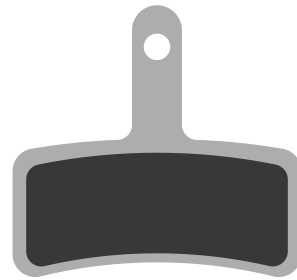

6905 - CARD

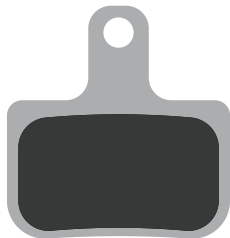

6906 - CARD / -BOX / -BOX25
 6906 S - CARD / -BOX / -BOX25
 6906 MC - CARD / -BOX / -BOX25

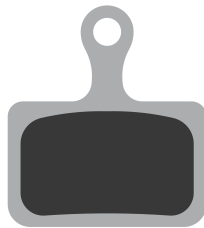

6907 - CARD / -BOX / -BOX25
 6907 S - CARD
 6907 MC - CARD / -BOX

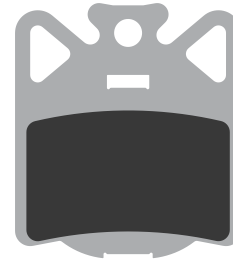

6908 - CARD

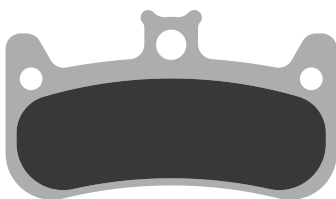

6909 - CARD
 6909 S - CARD
 6909 MC - CARD

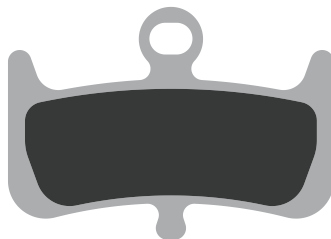

6910 - CARD
 6910 S - CARD
 6910 MC - CARD

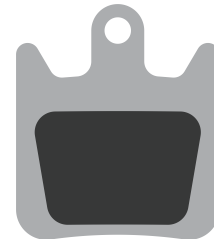

6911 - CARD
 6911 S - CARD
 6911 MC - CARD

BRAKE

- DISC BRAKE SYSTEMS
- CALIPER ADAPTERS
- CALIPER BOLTS
- DISC BRAKE ROTORS
- DISC BRAKE PARTS
- DISC BRAKE PADS
- RIM BRAKE PADS

CABLE

- INNER CABLES
- OUTER CABLES
- SUPERFLEX
- CABLE KITS
- CABLE PARTS

HYDRO

- ORIGINAL BRANDS
- HYDRO COMPONENTS
- SHIMANO HYDRO COMPONENTS
- O-RINGS

ROTATION

- BEARINGS
- HEADSET BEARINGS
- HEADSET PARTS
- PULLEY WHEELS
- BOTTOM BRACKET GUIDE
- BOTTOM BRACKETS
- BOTTOM BRACKET PARTS

TOOLS AND MAINTENANCE

- MAINTENANCE
- CABLE TOOLS
- HYDRO TOOLS
- MORE TOOLS
- BOTTOM BRACKET TOOLS

WORKSHOP

- TRANSIT
- BOXER
- PARTNER
- CADDY
- PADFINDER
- DISCOVERY

RIM BRAKE PAD GUIDE

☀️ BLACK COMPOUND

- For steel and aluminium rims
- Developed for dry conditions
- Excellent for city bike / trekking bike / racing bike



☁️ BLACK/RED COMPOUND

- For steel and aluminium rims
- Developed for wet conditions
- Excellent for MTB



☀️ ☁️ 📢 WHITE COMPOUND

- For steel and aluminium rims
- For more brake power
- Developed for dry and wet conditions
- Excellent for E-bike / racing bike / BMX



WHITE COMPOUND

This brake pad is specially developed for comfortable, powerful braking. Its unique white compound is silent and doesn't contaminate the rims with black residue.

☀️ ☁️ BLUE COMPOUND

- For carbon rims only
- Developed for dry and wet conditions
- Excellent for racing bike / BMX



How to replace
V-brake pads



ORDER QUANTITY

XXXX -CARD

All rim brake pads can be ordered per card, containing 1 pair.

XXXX -BOX

Select rim brake pads can be ordered per box, containing 25 pairs.

Fits Caddy display (page 80)



BRAKE

- DISC BRAKE SYSTEMS
- CALIPER ADAPTERS
- CALIPER BOLTS
- DISC BRAKE ROTORS
- DISC BRAKE PARTS
- DISC BRAKE PADS
- RIM BRAKE PADS

CABLE

- INNER CABLES
- OUTER CABLES
- SUPERFLEX
- CABLE KITS
- CABLE PARTS

HYDRO

- ORIGINAL BRANDS
- HYDRO COMPONENTS
- SHIMANO HYDRO COMPONENTS
- O-RINGS

ROTATION

- BEARINGS
- HEADSET BEARINGS
- HEADSET PARTS
- PULLEY WHEELS
- BOTTOM BRACKET GUIDE
- BOTTOM BRACKETS
- BOTTOM BRACKET PARTS

TOOLS AND MAINTENANCE

- MAINTENANCE
- CABLE TOOLS
- HYDRO TOOLS
- MORE TOOLS
- BOTTOM BRACKET TOOLS

WORKSHOP

- TRANSIT
- BOXER
- PARTNER
- CADDY
- PADFINDER
- DISCOVERY

6813

-CARD
Caliper
X-groove design



6843

-CARD
Caliper
X-groove design
More brake power
Less noise



6814

-CARD / -BOX
Power pads
compatible with
Magura HS11/33



6840

-CARD / -BOX
Power pads
compatible with
Magura HS11/33
More brake power
Less noise



6846

-CARD
Race
compatible with
Campagnolo
55 mm cartridge



6836

-CARD
Race
compatible with
Campagnolo
55 mm light weight cartridge
More brake power
Less noise



6844

-CARD
Race
compatible with
Campagnolo
55 mm light weight
cartridge
For carbon rims only



6822

-CARD
Race
compatible with
Campagnolo
55 mm replacement pad



6836, 6844, 6846

6838

-CARD
Race
compatible with
Campagnolo
55 mm replacement pad
More brake power
Less noise
6836, 6844, 6846



6826

-CARD
Race
compatible with
Campagnolo
55 mm replacement pad
For carbon rims only



6836, 6844, 6846

RIM BRAKE PADS

6808

-CARD
Cantilever
70 mm symmetrical



6812

-BOX
Cantilever
72 mm



6833

-CARD
Cantilever
55 mm cartridge
Cyclocross



6834

-CARD
Cantilever
55 mm replacement pad
Cyclocross
6833



6842

-CARD / -BOX
Race
compatible with Shimano
55 mm



6848

-CARD
Race
compatible with Shimano
55 mm
More brake power
Less noise



6847

-CARD
Race
compatible with Shimano
55 mm



6835

-CARD
Race
compatible with Shimano
55 mm light weight cartridge
More brake power
Less noise



6845

-CARD
Race
compatible with Shimano
55 mm
For carbon rims only



6810

-CARD / -BOX
Race
compatible with Shimano
55 mm replacement pad



6835, 6845, 6847

6837

-CARD
Race
compatible with Shimano
55 mm replacement pad
More brake power
Less noise
6835, 6845, 6847



6827

-CARD
Race
compatible with Shimano
55 mm replacement pad
For carbon rims only
6835, 6845, 6847



6807

-CARD / -BOX
V-brake pads
55 mm replacement pad



6816

-CARD / -BOX
V-brake pads
70 mm symmetrical



6806

-CARD / -BOX
V-brake pads
72 mm



6828

-BOX
V-brake pads
72 mm
ABS design



6815

-CARD / -BOX
V-brake pads
72 mm
Special groove design



6832

-CARD / -BOX
V-brake pads
72 mm
More brake power
Less noise



6804

-CARD
V-brake pads
72 mm cartridge



6802

-CARD
V-brake pads
72 mm cartridge
Special groove design



6805

-CARD / -BOX
V-brake pads
72 mm replacement pad



6803

-CARD
V-brake pads
72 mm cartridge
Special groove design



6802, 6804

6802, 6804

6841

-CARD
V-brake pads
72 mm replacement pad
More brake power
Less noise
6802, 6804



6839

-CARD
V-brake pads
72 mm cartridge
For carbon rims only



6802, 6804

BRAKE

DISC BRAKE SYSTEMS
CALIPER ADAPTERS
CALIPER BOLTS
DISC BRAKE ROTORS
DISC BRAKE PARTS
DISC BRAKE PADS
RIM BRAKE PADS

CABLE

INNER CABLES
OUTER CABLES
SUPERFLEX
CABLE KITS
CABLE PARTS

HYDRO

ORIGINAL BRANDS
HYDRO COMPONENTS
SHIMANO HYDRO COMPONENTS
O-RINGS

ROTATION

BEARINGS
HEADSET BEARINGS
HEADSET PARTS
PULLEY WHEELS
BOTTOM BRACKET GUIDE
BOTTOM BRACKETS
BOTTOM BRACKET PARTS

TOOLS AND MAINTENANCE

MAINTENANCE
CABLE TOOLS
HYDRO TOOLS
MORE TOOLS
BOTTOM BRACKET TOOLS

WORKSHOP

TRANSIT
BOXER
PARTNER
CADDY
PADFINDER
DISCOVERY

CABLE



VOLUME BOX

G - Galvanised
S - Stainless steel

Fits Boxer display (page 78)



VOLUME BOX

The easy pull system ensures the inner cables can be easily taken out of the box without getting tangled.



19 strands Regular



19 strands slick Extra smooth

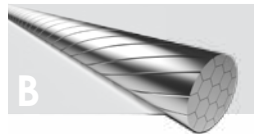

49 (7x7) strands Extra flexible

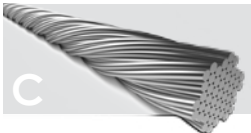

49 (7x7) strands slick Extra flexible, extra smooth



31 strands slick Medium flexible, extra smooth

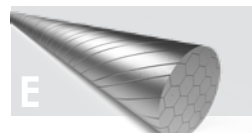

INNER CABLES

Flexible, extra smooth inner cables (D,E) are ideal for easily running through an outer cable with a lot of bends.

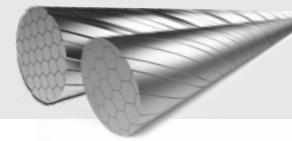

BRAKE

6426RVS-BOX	S	2 000 mm	A	100 pcs
6426RVS-SLICK-BOX	S	2 000 mm	B	100 pcs
6427RVS-BOX	S	2 250 mm	A	100 pcs
6427RVS-SLICK-BOX	S	2 250 mm	B	100 pcs
6427RVS-49-BOX	S	2 250 mm	C	100 pcs
6427RVS-3M-BOX	S	3 000 mm	A	50 pcs

BRAKE

6411RVS-BOX	S	2 000 mm	A	100 pcs
6411RVS-SLICK-BOX	S	2 000 mm	B	100 pcs
6411RVS-49-BOX	S	2 000 mm	C	100 pcs

SHIFT

6472RVS-BOX	S	2 250 mm	A	100 pcs
6472RVS-SLICK-BOX	S	2 250 mm	B	100 pcs
6472RVS-49-BOX	S	2 250 mm	C	100 pcs
+ 6472RVS-49-SLICK-BOX	S	2 250 mm	D	50 pcs
6472RVS-3M-BOX	S	3 000 mm	A	50 pcs

SHIFT

Only compatible with Shimano and SRAM

6472RVS-SHIM-BOX	S	2 250 mm	A	100 pcs
6472RVS-SHIM-SL-BOX	S	2 250 mm	B	100 pcs
+ 6472RVS-SH-49-SL-BOX	S	2 250 mm	D	50 pcs
+ 2021056-BOX	S	2 250 mm	E	50 pcs

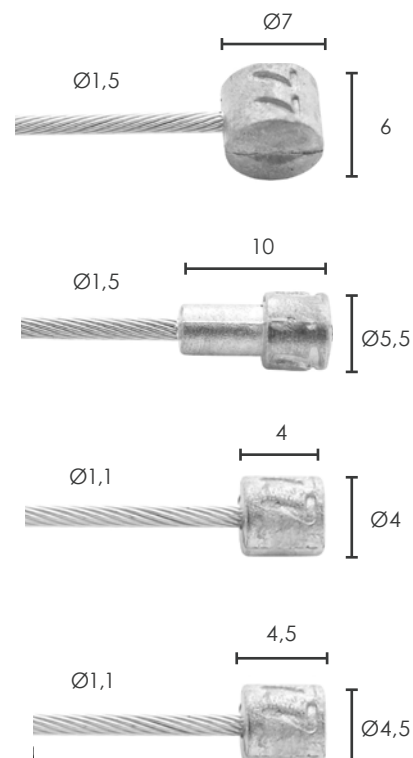

BRAKE

DISC BRAKE SYSTEMS
CALIPER ADAPTERS
CALIPER BOLTS
DISC BRAKE ROTORS
DISC BRAKE PARTS
DISC BRAKE PADS
RIM BRAKE PADS

CABLE

INNER CABLES
OUTER CABLES
SUPERFLEX
CABLE KITS
CABLE PARTS

HYDRO

ORIGINAL BRANDS
HYDRO COMPONENTS
SHIMANO HYDRO COMPONENTS
O-RINGS

ROTATION

BEARINGS
HEADSET BEARINGS
HEADSET PARTS
PULLEY WHEELS
BOTTOM BRACKET GUIDE
BOTTOM BRACKETS
BOTTOM BRACKET PARTS

TOOLS AND MAINTENANCE

MAINTENANCE
CABLE TOOLS
HYDRO TOOLS
MORE TOOLS
BOTTOM BRACKET TOOLS

WORKSHOP

TRANSIT
BOXER
PARTNER
CADDY
PADFINDER
DISCOVERY

INNER CABLES

CARD

Types of inner cables

G - Galvanised
S - Stainless steel

**19 strands
Regular**

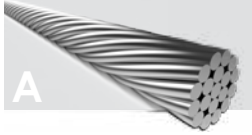

**19 strands slick
Extra smooth**

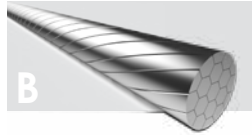

**49 (7x7) strands
Extra flexible**

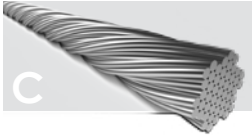

**49 (7x7) strands slick
Extra flexible, extra smooth**



**31 strands slick
Medium flexible, extra smooth**

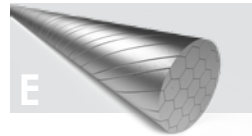

INNER CABLES

Flexible, extra smooth inner cables (D,E) are ideal for easily running through an outer cable with a lot of bends.

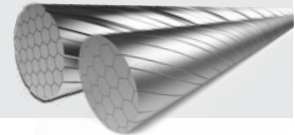

BRAKE

6414	G	900 mm	A	20 pcs
6414RVS	S	1 000 mm	A	20 pcs
6416	G	1 250 mm	A	20 pcs
6416RVS	S	1 250 mm	A	20 pcs
6426	G	2 000 mm	A	20 pcs
6426RVS	S	2 000 mm	A	20 pcs
6426RVS-SLICK	S	2 000 mm	B	20 pcs
6427	G	2 250 mm	A	20 pcs
6427RVS	S	2 250 mm	A	20 pcs
6427RVS-SLICK	S	2 250 mm	B	20 pcs
6427RVS-49	S	2 250 mm	C	20 pcs
6427-3M	G	3 000 mm	A	15 pcs
6427RVS-3M	S	3 000 mm	A	15 pcs
6427RVS-5M	S	5 000 mm	A	10 pcs



BRAKE

6412/27	G	2 250 mm	A	20 pcs
6412/27RVS	S	2 350 mm	A	20 pcs
6412/27RVS-SLICK	S	2 350 mm	B	20 pcs
6412/27RVS-49	S	2 250 mm	C	20 pcs
6412/27RVS-3M	S	3 000 mm	A	15 pcs
6412/27-4M	G	4 000 mm	A	10 pcs
6412/27RVS-4M	S	4 000 mm	A	10 pcs

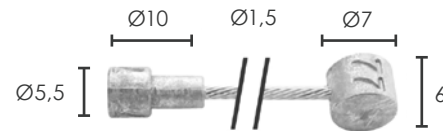

BRAKE

6411	G	2 000 mm	A	20 pcs
6411RVS	S	2 000 mm	A	20 pcs
6411RVS-SLICK	S	2 000 mm	B	20 pcs
6412	G	2 250 mm	A	20 pcs
6412RVS	S	2 250 mm	A	20 pcs
6412RVS-SLICK	S	2 250 mm	B	20 pcs
6412-49	G	2 250 mm	C	20 pcs
6412RVS-49	S	2 250 mm	C	20 pcs

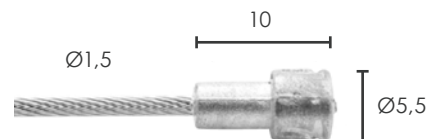

SHIFT

Only compatible with Shimano and SRAM

6472RVS-SHIM	S	2 250 mm	A	20 pcs/carton
6472RVS-SHIM-SLICK	S	2 250 mm	B	20 pcs/carton
+ 6472RVS-SHIM-49-SL	S	2 250 mm	D	20 pcs/carton
+ 2020213	S	4 000 mm	D	15 pcs/carton
+ 2021056	S	2 250 mm	E	20 pcs/carton
+ 2021057	S	4 000 mm	E	15 pcs/carton

SHIFT

6446	G	2 250 mm	A	20 pcs/carton
6446RVS	S	2 250 mm	A	20 pcs/carton

SHIFT

6400	G	2 250 mm	A	20 pcs/carton
6400RVS	S	2 250 mm	A	20 pcs/carton
6400RVS-3M	S	3 000 mm	A	15 pcs/carton

SHIFT

6446-1	G	2 250 mm	A	20 pcs/carton
6472RVS	S	2 250 mm	A	20 pcs/carton
6472RVS-SLICK	S	2 250 mm	B	20 pcs/carton
6472RVS-3M	S	3 000 mm	A	20 pcs/carton
6472RVS-49	S	2 250 mm	C	20 pcs/carton
+ 6472RVS-49-SLICK	S	2 250 mm	D	20 pcs/carton
6472RVS-4M	S	4 000 mm	A	15 pcs/carton
6472RVS-5M	S	5 000 mm	A	15 pcs/carton

SHIFT

6451/72RVS	S	2 250 mm	A	20 pcs/carton
6451/72RVS-3M	S	3 000 mm	A	20 pcs/carton

SHIFT

6451/18	G	2 250 mm	A	20 pcs/carton
---------	---	----------	---	---------------

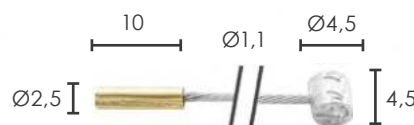
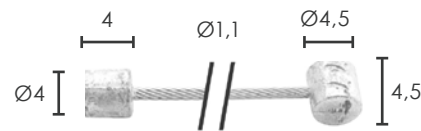
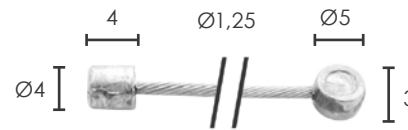
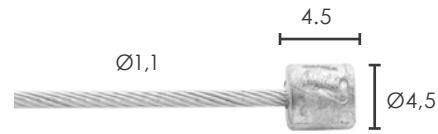

BRAKE

- DISC BRAKE SYSTEMS
- CALIPER ADAPTERS
- CALIPER BOLTS
- DISC BRAKE ROTORS
- DISC BRAKE PARTS
- DISC BRAKE PADS
- RIM BRAKE PADS

CABLE

- INNER CABLES
- OUTER CABLES
- SUPERFLEX
- CABLE KITS
- CABLE PARTS

HYDRO

- ORIGINAL BRANDS
- HYDRO COMPONENTS
- SHIMANO HYDRO COMPONENTS
- O-RINGS

ROTATION

- BEARINGS
- HEADSET BEARINGS
- HEADSET PARTS
- PULLEY WHEELS
- BOTTOM BRACKET GUIDE
- BOTTOM BRACKETS
- BOTTOM BRACKET PARTS

TOOLS AND MAINTENANCE

- MAINTENANCE
- CABLE TOOLS
- HYDRO TOOLS
- MORE TOOLS
- BOTTOM BRACKET TOOLS

WORKSHOP

- TRANSIT
- BOXER
- PARTNER
- CADDY
- PADFINDER
- DISCOVERY



VOLUME BOX

All Elvedes outer cables have MoS₂ enriched liner for lower friction and higher performance.

The outer cable volume boxes come with an easy pull reel made of 100% recycled and 100% recyclable plastic.

The boxes are also equipped with a unique GripClip, which prevents the outer cable from slipping back into the box after cutting.

Fits Boxer display (page 78)



The cable type is indicated by the letter A, B, C or D

Brake cable



Braided brake cable



Shift cable



Braided shift / brake cable



SHIFT Ø4,1

Box 30m	Bag 10m	Colour
1120SP-1-BOX	1120SP-1-10	C Black
1120SP-3-BOX	1120SP-3-10	C Silver
1120SP-6-BOX	1120SP-6-10	C White
1120SP-7-BOX	1120SP-7-10	C Red
1120SP-8-BOX	1120SP-8-10	C Blue
1120SP-9-BOX	1120SP-9-10	C Orange
1120SP-10-BOX	1120SP-10-10	C Green
1120SP-11-BOX	1120SP-11-10	C Neon orange
1120SP-12-BOX	1120SP-12-10	C Neon yellow
1120SP-13-BOX	1120SP-13-10	C Neon green
1120SP-14-BOX	1120SP-14-10	C Yellow
1120SP-15-BOX	1120SP-15-10	C Pink
2019089-BOX	2019089-10	C Brown
2019091-BOX	2019091-10	C Celeste

SHIFT Ø4,9

Box 30m	Bag 10m	Colour
1125SP-1-BOX	1125SP-1-10	C Black
1125SP-3-BOX	1125SP-3-10	C Silver
182041-BOX	182041-10	D Silver
182042-BOX	182042-10	D Smoke silver
182043-BOX	182043-10	D Titanium

BRAKE Ø4,9

Box 30m	Bag 10m	Colour
1125-BOX	1125-10	- Black
1125TEF-1-BOX	1125TEF-1-10	A Black
1125TEF-2-BOX	1125TEF-2-10	A Grey
1125TEF-3-BOX	1125TEF-3-10	A Silver
1125TEF-6-BOX	1125TEF-6-10	A White
1125TEF-7-BOX	1125TEF-7-10	A Red
1125TEF-8-BOX	1125TEF-8-10	A Blue
1125TEF-9-BOX	1125TEF-9-10	A Orange
1125TEF-10-BOX	1125TEF-10-10	A Green
1125TEF-11-BOX	1125TEF-11-10	A Neon orange
1125TEF-12-BOX	1125TEF-12-10	A Neon yellow
1125TEF-13-BOX	1125TEF-13-10	A Neon green
1125TEF-14-BOX	1125TEF-14-10	A Yellow
1125TEF-15-BOX	1125TEF-15-10	A Pink
2019088-BOX	2019088-10	A Brown
2019090-BOX	2019090-10	A Celeste
1125LSR-6-BOX	1125LSR-6-10	A Black/chrome
1125LSR-7-BOX	1125LSR-7-10	A Chrome
182038-BOX	182038-10	B Silver
182039-BOX	182039-10	B Smoke silver
182040-BOX	182040-10	B Titanium

BRAKE AND SHIFT Ø4,9

Box 30m	Bag 10m	Colour
2010016-BOX	2010016-10	D Carbon
2020256-BOX	2020256-10	D Black



Linear outer cable for powerful braking and precise shifting. Excellent for cargo bikes, tandems and mechanical disc brakes.

SUPERFLEX



SUPERFLEX OUTER CABLES

Flexible, small diameter outer cables are ideal for internal cable guiding and easily cornering all kinds of edges. Excellent for dropper-posts and lock-out remotes

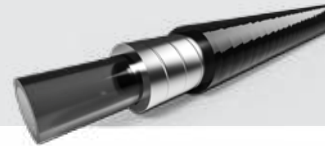

VOLUME BOX

2022018
 Ø3,65
 Black
 Box 30m



Fits Boxer display (page 78)

FERRULES

ELV2021080
 Ø3,65 to Ø5,5
 Aluminium
 50 pcs



SHIFT OT-RS900

2021073	240 mm	Black	1 pce/bag, 15 bags/carton
2021074	240 mm	Black	10 pcs/bag, 15 bags/carton



SUPERFLEX INNER CABLES

Flexible, extra smooth inner cables (D,E) are ideal for easily running through an outer cable with a lot of bends.

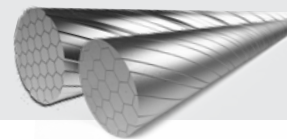

VOLUME BOX

Only compatible with Shimano and SRAM
 Fits Boxer display (page 78)

6472RVS-SH-49-SL-BOX	S	2 250 mm	D	50 pcs
2021056-BOX	S	2 250 mm	E	50 pcs

CARD

Only compatible with Shimano and SRAM

6472RVS-SHIM-49-SL	S	2 250 mm	D	20 pcs/carton
2020213	S	4 000 mm	D	15 pcs/carton
2021056	S	2 250 mm	E	20 pcs/carton
2021057	S	4 000 mm	E	15 pcs/carton



CABLE KIT DROPPER-POST AND LOCK-OUT REMOTES

(excl. remote)

2021081

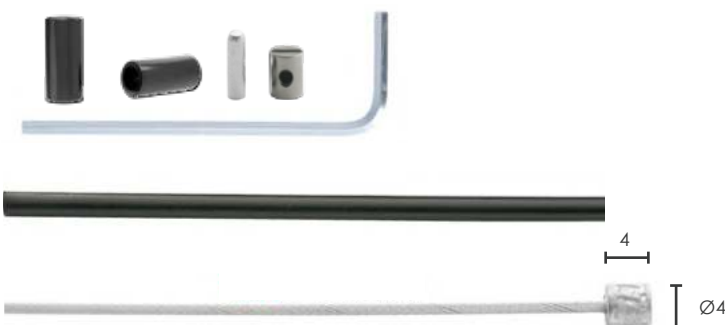

BRAKE

- DISC BRAKE SYSTEMS
- CALIPER ADAPTERS
- CALIPER BOLTS
- DISC BRAKE ROTORS
- DISC BRAKE PARTS
- DISC BRAKE PADS
- RIM BRAKE PADS

CABLE

- INNER CABLES
- OUTER CABLES
- SUPERFLEX
- CABLE KITS
- CABLE PARTS

HYDRO

- ORIGINAL BRANDS
- HYDRO COMPONENTS
- SHIMANO HYDRO COMPONENTS
- O-RINGS

ROTATION

- BEARINGS
- HEADSET BEARINGS
- HEADSET PARTS
- PULLEY WHEELS
- BOTTOM BRACKET GUIDE
- BOTTOM BRACKETS
- BOTTOM BRACKET PARTS

TOOLS AND MAINTENANCE

- MAINTENANCE
- CABLE TOOLS
- HYDRO TOOLS
- MORE TOOLS
- BOTTOM BRACKET TOOLS

WORKSHOP

- TRANSIT
- BOXER
- PARTNER
- CADDY
- PADFINDER
- DISCOVERY

CABLE KITS

CABLE KIT

All cable kits fit Shimano, Campagnolo and SRAM

19 strands regular



49 (7x7) strands slick
Extra flexible, extra smooth



BRAKE CABLE KIT

fits MTB and road systems

2015009	A	Black	
2015010	A	Silver	
2015011	A	White	
2015012	A	Red	
2015013	A	Blue	
2015014	A	Orange	
2015015	A	Green	
2017150	A	Pink	
2017152	A	Yellow	

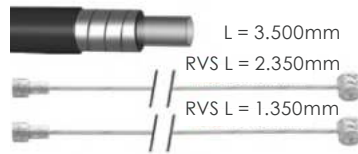

SHIFT CABLE KIT

fits MTB and road systems

2015002	A	Black	
2015003	A	Silver	
2015004	A	White	
2015005	A	Red	
2015006	A	Blue	
2015007	A	Orange	
2015008	A	Green	
2017151	A	Pink	
2017153	A	Yellow	

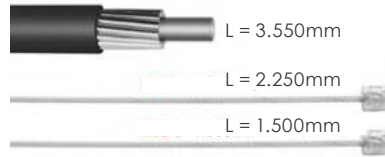

1X SHIFT CABLE KIT

	2021040	D	Black	
--	---------	---	-------	--

FREESTYLE CABLE REAR

6489 1 pce



FREESTYLE CABLE FRONT

6484 1 pce





UNIVERSAL CABLE SPLITTER SET

Operates 2 brakes with 1 brake lever.

Includes a unique part (D) to add an optional ABS function.

Easy and quick assembly.

2017161

Inner cables included.
Outer cables not included.

- | | |
|---------------------|-------------------------|
| A Body | E O-ring |
| B Cap | F M3 fixing bolt |
| C Piston | G Allen key |
| D ABS insert | |

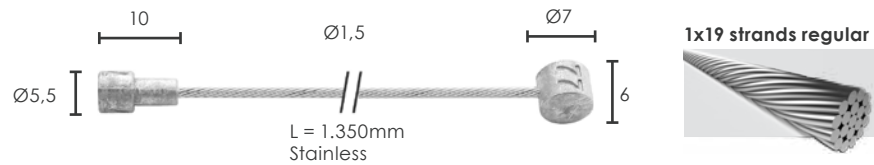

1x19 strands regular

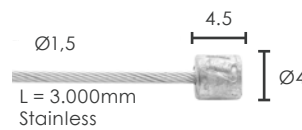
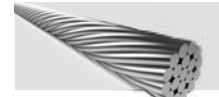

49 (7x7) strands extra flexible

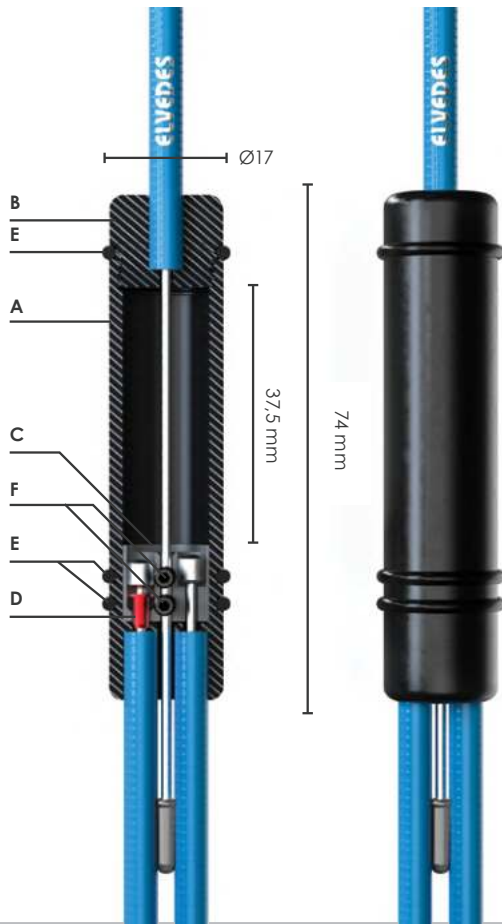

Replacement inner cable (upper)

for universal cable splitter

6412/27RVS/1.35 Stainless 1 350 mm 20 pcs/carton

Replacement inner cable (lower)

for universal cable splitter

2017145 Stainless 3 000 mm 15 pcs/carton

Scan this code for instructions



BRAKE

- DISC BRAKE SYSTEMS
- CALIPER ADAPTERS
- CALIPER BOLTS
- DISC BRAKE ROTORS
- DISC BRAKE PARTS
- DISC BRAKE PADS
- RIM BRAKE PADS

CABLE

- INNER CABLES
- OUTER CABLES
- SUPERFLEX
- CABLE KITS
- CABLE PARTS

HYDRO

- ORIGINAL BRANDS
- HYDRO COMPONENTS
- SHIMANO HYDRO COMPONENTS
- O-RINGS

ROTATION

- BEARINGS
- HEADSET BEARINGS
- HEADSET PARTS
- PULLEY WHEELS
- BOTTOM BRACKET GUIDE
- BOTTOM BRACKETS
- BOTTOM BRACKET PARTS

TOOLS AND MAINTENANCE

- MAINTENANCE
- CABLE TOOLS
- HYDRO TOOLS
- MORE TOOLS
- BOTTOM BRACKET TOOLS

WORKSHOP

- TRANSIT
- BOXER
- PARTNER
- CADDY
- PADFINDER
- DISCOVERY

CABLE KITS

CARD

All cable kits are available per card.
Cards per carton are mentioned per item no.

Types of inner cables

- G** - Galvanised
- S** - Stainless steel



BRAKE

2021071 1 800 mm Black 15 pcs/carton



SHIFT

2021072 2 000 mm Black 15 pcs/carton



DRUMBRAKE

6473 G 2 250 mm 14 pcs/carton
6473RVS S 2 350 mm 14 pcs/carton



DRUMBRAKE

6269SP G 1 800 mm 2 250 mm Black 15 pcs/carton
6269SP-RVS S 1 800 mm 2 350 mm Black 15 pcs/carton
6269SP-3 S 1 800 mm 2 350 mm Silver 15 pcs/carton



DRUMBRAKE

6268SP G 1 100 mm 1 250 mm Black 15 pcs/carton
6268SP-RVS S 1 100 mm 1 350 mm Black 15 pcs/carton
6268SP-3 S 1 100 mm 1 350 mm Silver 15 pcs/carton



BRAKE UNIVERSAL

6445 G 1 800 mm 2 250 mm Black 15 pcs/carton
6445RVS S 1 800 mm 2 350 mm Black 15 pcs/carton
6445-3 S 1 800 mm 2 350 mm Silver 15 pcs/carton



BRAKE 2 NIPPLES

6444/39 G 1 800 mm 2 250 mm Black 15 pcs/carton
6444/39-RVS S 1 800 mm 2 350 mm Black 15 pcs/carton



BRAKE

6439 G 1 800 mm 2 000 mm Black 15 pcs/carton

BRAKE

6436 G 540 mm 900 mm Black 15 pcs/carton
 6436RVS S 540 mm 900 mm Black 15 pcs/carton
 6444 G 1 800 mm 2 000 mm Black 15 pcs/carton
 6444RVS S 1 800 mm 2 000 mm Black 15 pcs/carton

ROLLERBRAKE BR-IM45/55/80/81/85

2012025 S 1 100 mm 1 250 mm Black 15 pcs/carton
 2012026 S 1 100 mm 1 250 mm Silver 15 pcs/carton
 2012027 S 1 800 mm 2 250 mm Black 15 pcs/carton
 2012028 S 1 800 mm 2 250 mm Silver 15 pcs/carton

ROLLERBRAKE BR-IM41/50/53

6282 S 1 100 mm 1 250 mm Black 15 pcs/carton
 6283 S 1 800 mm 2 250 mm Black 15 pcs/carton
 6284 S 1 100 mm 1 250 mm Silver 15 pcs/carton
 6285 S 1 800 mm 2 250 mm Silver 15 pcs/carton

SHIFT STURMEY ARCHER UNIVERSAL

6478 G 1 800 mm 2 250 mm Black 15 pcs/carton
 6478-3 S 1 800 mm 2 250 mm Silver 15 pcs/carton

NEXUS 4/7/8 SPEED

6286 S 2 000 mm 2 250 mm Black 15 pcs/carton
 6287 S 2 000 mm 2 250 mm Silver 15 pcs/carton

SHIFT FOR ALL DERAILLEURS + NEXUS 3 SPEED

6479 S 2 000 mm 2 250 mm Black 15 pcs/carton
 6479-3 S 2 000 mm 2 250 mm Silver 15 pcs/carton

SHIFT SRAM UNIVERSAL

6477 G 1 800 mm 2 250 mm Black 15 pcs/carton



BRAKE

DISC BRAKE SYSTEMS
 CALIPER ADAPTERS
 CALIPER BOLTS
 DISC BRAKE ROTORS
 DISC BRAKE PARTS
 DISC BRAKE PADS
 RIM BRAKE PADS

CABLE

INNER CABLES
 OUTER CABLES
 SUPERFLEX
 CABLE KITS
 CABLE PARTS

HYDRO

ORIGINAL BRANDS
 HYDRO COMPONENTS
 SHIMANO HYDRO COMPONENTS
 O-RINGS

ROTATION

BEARINGS
 HEADSET BEARINGS
 HEADSET PARTS
 PULLEY WHEELS
 BOTTOM BRACKET GUIDE
 BOTTOM BRACKETS
 BOTTOM BRACKET PARTS

TOOLS AND MAINTENANCE

MAINTENANCE
 CABLE TOOLS
 HYDRO TOOLS
 MORE TOOLS
 BOTTOM BRACKET TOOLS

WORKSHOP

TRANSIT
 BOXER
 PARTNER
 CADDY
 PADFINDER
 DISCOVERY

ASSORTMENT BOX COLOURED FERRULES AND END CAPS

2012020

For consumer packaging: CPxxxx

For workshop packaging: ELVxxxx

Contains:

100 aluminium end caps of each colour

25 aluminium ferrules of each size/colour



ELV2012001

Ferrule with seal

Ø5,0 mm

Aluminium

50 pcs



CP2012001 10 pcs

ELV2012007

Ferrule with seal

Ø4,3 mm

Aluminium

50 pcs



CP2012007 10 pcs

ELV1171

End cap

Ø2,3 mm

Aluminium

500 pcs



CP1171 10 pcs

ELV2012002

Ferrule with seal

Ø5,0 mm

Aluminium

50 pcs



CP2012002 10 pcs

ELV2012008

Ferrule with seal

Ø4,3 mm

Aluminium

50 pcs



CP2012008 10 pcs

ELV2012013

End cap

Ø2,3 mm

Aluminium

500 pcs



CP2012013 10 pcs

ELV2012004

Ferrule with seal

Ø5,0 mm

Aluminium

50 pcs



CP2012004 10 pcs

ELV2012010

Ferrule with seal

Ø4,3 mm

Aluminium

50 pcs



CP2012010 10 pcs

ELV2012015

End cap

Ø2,3 mm

Aluminium

500 pcs



CP2012015 10 pcs

ELV2012003

Ferrule with seal

Ø5,0 mm

Aluminium

50 pcs



CP2012003 10 pcs

ELV2012009

Ferrule with seal

Ø4,3 mm

Aluminium

50 pcs



CP2012009 10 pcs

ELV2012014

End cap

Ø2,3 mm

Aluminium

500 pcs



CP2012014 10 pcs

ELV2012006

Ferrule with seal

Ø5,0 mm

Aluminium

50 pcs



CP2012006 10 pcs

ELV2012012

Ferrule with seal

Ø4,3 mm

Aluminium

50 pcs



CP2012012 10 pcs

ELV2012017

End cap

Ø2,3 mm

Aluminium

500 pcs



CP2012017 10 pcs

ELV2012005

Ferrule with seal

Ø5,0 mm

Aluminium

50 pcs



CP2012005 10 pcs

ELV2012011

Ferrule with seal

Ø4,3 mm

Aluminium

50 pcs



CP2012011 10 pcs

ELV2012016

End cap

Ø2,3 mm

Aluminium

500 pcs



CP2012016 10 pcs

ALL PARTS AVAILABLE IN CONSUMER AND WORKSHOP PACKAGING

For consumer packaging: CPxxxx

For workshop packaging: ELVxxxx - Fits Partner display (page 79)

ELV2016108

Ferrule

Ø4,3 to Ø4,75 mm
Brass
150 pcs



ELV2016107

Ferrule

Ø4,3 to Ø5,7 mm
Brass
150 pcs



CP2016107

10 pcs

ELV1160PRESSED

Ferrule

Ø5,0 mm
Brass
200 pcs



ELV1160

Ferrule CNC

Ø5,0 mm
Brass
200 pcs



ELV1167

Ferrule push fit

Ø5,0 mm
Brass
200 pcs



ELV1130

Ferrule S.A.

Ø5,0 mm
Brass
50 pcs



CP1160

10 pcs

ELV1001

Ferrule Weinmann

Ø5,5 mm
Aluminium
100 pcs



ELV1161

Ferrule with seal

Ø5,0 mm
Brass
100 pcs



ELV2015057

Ferrule with seal

Ø4,3 mm
PA6
100 pcs



ELV1160PVC4-1

Ferrule

Ø4,3 mm
PA6
150 pcs



ELV1160PVC4-3

Ferrule

Ø4,3 mm
PA6
150 pcs



ELV1160PVC5-1

Ferrule

Ø5,0 mm
PA6
150 pcs



CP1160PVC4-1

10 pcs

CP1160PVC5-1

10 pcs

ELV1160PVC5-3

Ferrule

Ø5,0 mm
PA6
150 pcs



ELV2012107

Ferrule with tip

Ø4,3 mm
PA6
50 pcs



ELV2012106

Ferrule with tip

Ø5 mm
PA6
50 pcs



ELV2021080

Ferrule

Ø3,65 to Ø5,5
Aluminium
50 pcs



ELV1071

Adjuster

M5
Brass
15 pcs



ELV1072

Adjuster

M6
Brass
15 pcs



BRAKE

DISC BRAKE SYSTEMS

CALIPER ADAPTERS

CALIPER BOLTS

DISC BRAKE ROTORS

DISC BRAKE PARTS

DISC BRAKE PADS

RIM BRAKE PADS

CABLE

INNER CABLES

OUTER CABLES

SUPERFLEX

CABLE KITS

CABLE PARTS

HYDRO

ORIGINAL BRANDS

HYDRO COMPONENTS

SHIMANO HYDRO COMPONENTS

O-RINGS

ROTATION

BEARINGS

HEADSET BEARINGS

HEADSET PARTS

PULLEY WHEELS

BOTTOM BRACKET GUIDE

BOTTOM BRACKETS

BOTTOM BRACKET PARTS

TOOLS AND MAINTENANCE

MAINTENANCE

CABLE TOOLS

HYDRO TOOLS

MORE TOOLS

BOTTOM BRACKET TOOLS

WORKSHOP

TRANSIT

BOXER

PARTNER

CADDY

PADFINDER

DISCOVERY

CABLE PARTS

ALL PARTS AVAILABLE IN CONSUMER AND WORKSHOP PACKAGING

For consumer packaging: CPxxxx
For workshop packaging: ELVxxxx

ELV1090

Adjuster
M6
Aluminium
25 pcs



ELV2015139

Adjuster barrel
Ø4,3 mm
Steel
15 pcs



CP2015139 2 pcs

ELV2015140

Adjuster barrel
Ø4,3 mm
Aluminium
15 pcs



CP2015140 2 pcs

ELV1073

Adjuster for cable
M6
Brass
10 pcs



ELV2020100

Adjuster for lever
M7
Aluminium
15 pcs



ELV2020099

Adjuster for lever
M10
Aluminium
15 pcs



ELV2011003

Adjuster for rollerbrake
M6
Brass
15 pcs



ELV2014062

Adjuster inline
Ø4,3 mm
Aluminium
15 pcs



CP2014062 2 pcs

ELV2015173

Adjuster inline
Ø5,0 mm
Aluminium
15 pcs



CP2015173 2 pcs

ELV2011004

Cable bolt for Nexus
4/7/8 speed
Brass
15 pcs



ELV2011002

Cable bolt for rollerbrake
BR-IM41/50/53
Brass
15 pcs



ELV2012024

Cable bolt for rollerbrake
BR-IM85/81/
80/55/45
Brass
15 pcs



ELV2012023

E-cap
Fits 2012024
POM
25 pcs



ELV1140

Cable bolt N-type
Ø7 × 10 mm
Brass
50 pcs



ELV1144

Cable bolt N-type
Ø8 × 14 mm
Brass
50 pcs



ELV1141

Cable bolt T-type
Ø5 × 7 mm
Brass
50 pcs



ELV1142

Cable bolt T-type
Ø6 × 14 mm
Brass
50 pcs



ELV1143

Cable bolt T-type
Ø8 × 15 mm
Brass
25 pcs



ELV6482/73

Linkwire
73 mm
Steel
10 pcs



ELV6482/82

Linkwire
82 mm
Steel
10 pcs



ELV6482/93

Linkwire
93 mm
Steel
10 pcs



ELV6482/106

Linkwire
106 mm
Steel
10 pcs



ELV1178

Open end cap
Ø5,0 mm
Aluminium
25 pcs



ELV1174

O-ring brake/shift
Ø1,1 - 1,5 mm
Rubber
250 pcs



ELV201211

Rubber boot
0,8 - 1,2 mm
Rubber
15 pcs



ELV1163

Rubber boot for V-brake
35 mm
Rubber
15 pcs



ELV2015143

Rubber boot for V-brake
35 mm
Rubber
15 pcs



ELV9009

Tensioner drumbrake universal
M4,5
Brass
10 pcs



ELV4545

Tensioner S.A. universal
25 mm
Brass
15 pcs



ELV5050

Tensioner SRAM T3
Ø1,5 mm
PA-GF
10 pcs



CP2019094

V-brake pipe 90° adjustable
Ø5,0 mm
Stainless steel
2 pcs



CP2019230

V-brake pipe 90° adjustable, short
Ø5,0 mm
Stainless steel
2 pcs



ELV2018061

V-brake pipe 90° black
Ø5,0 mm
Stainless steel
10 pcs



ELV1162-90

V-brake pipe 90°
Ø5,0 mm
Stainless steel
10 pcs



ELV1162-110

V-brake pipe 110°
Ø5,0 mm
Stainless steel
10 pcs



ELV1162-130

V-brake pipe 130°
Ø5,0 mm
Stainless steel
10 pcs



ELV1162

V-brake pipe flex
Ø5,0 mm
Stainless steel
10 pcs



ELV2012032

V-brake pipe flex incl. rubber boot
Ø5,0 mm
Stainless steel
10 pcs



CP2012032 1 pce

CP2017093

V-brake pipe flex, adjustable
Ø5,0 mm
Aluminium
2 pcs



BRAKE

DISC BRAKE SYSTEMS
CALIPER ADAPTERS
CALIPER BOLTS
DISC BRAKE ROTORS
DISC BRAKE PARTS
DISC BRAKE PADS
RIM BRAKE PADS

CABLE

INNER CABLES
OUTER CABLES
SUPERFLEX
CABLE KITS
CABLE PARTS

HYDRO

ORIGINAL BRANDS
HYDRO COMPONENTS
SHIMANO HYDRO COMPONENTS
O-RINGS

ROTATION

BEARINGS
HEADSET BEARINGS
HEADSET PARTS
PULLEY WHEELS
BOTTOM BRACKET GUIDE
BOTTOM BRACKETS
BOTTOM BRACKET PARTS

TOOLS AND MAINTENANCE

MAINTENANCE
CABLE TOOLS
HYDRO TOOLS
MORE TOOLS
BOTTOM BRACKET TOOLS

WORKSHOP

TRANSIT
BOXER
PARTNER
CADDY
PADFINDER
DISCOVERY

CABLE PARTS

ALL PARTS AVAILABLE IN CONSUMER AND WORKSHOP PACKAGING

For consumer packaging: CPxxxx
For workshop packaging: ELVxxxx

ELV2020102

Cable clip duo
4,1 + 4,1 mm
PA6
50 pcs



CP2020102

10 pcs

ELV2020101

Cable clip duo
5,0 + 2,5 mm (Di2)
PA6
50 pcs



CP2020101

10 pcs

ELV2020103

Cable clip duo
5,0 + 4,1 mm
PA6
50 pcs



CP2020103

10 pcs

ELV2020104

Cable clip duo
5,0 + 5,0 mm
PA6
50 pcs



CP2020104

10 pcs

ELV1075

Cable clip
Ø5,0 mm
PP
20 pcs



ELV2015142

Cable clip for frame notch
Ø5,0 mm
50 pcs



CP2015142

2 pcs

ELV2015141

Cable clip rotating
Ø4,3 - 5,0 mm
50 pcs



CP2015141

4 pcs

CP2019093

Cable guide pipe short
Ø5,0 mm
Aluminium
2 pcs



CP2015144

Cable hanger for cyclo-cross
Aluminium
1 pce



ELV6464

Cantilever cable
Ø1,5 mm
extra flexible
Stainless steel
20 pcs



ELV2019095

Cantilever cable bolt
Brass
10 pcs



2010015

Dual brake lever with parking stop
Ø23 mm
Steel
1 pce



ELV1171

End cap
Ø2,3 mm
Aluminium
500 pcs



CP1171

10 pcs

ELV1172

End cap
Ø1,6 mm
Aluminium
500 pcs



CP1172

10 pcs

ELV2018036

Extension ferrule
Ø4,3 mm
Aluminium
25 pcs

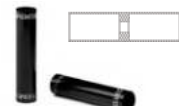

ELV2018035

Extension ferrule
Ø5,0 mm
Aluminium
25 pcs

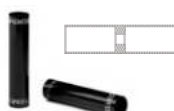

ELV1176

Frame protector
Ø4,3 - 5,0 mm
Rubber
25 pcs



ELV2011001

Frame protector
Ø4,3 - 5,0 mm
Rubber
25 pcs



CP2011001

4 pcs

CABLE LINER

2016116

Ø2.0 / 2.6 mm
L= 25mtr
HDPE



CABLE LINER WITH TRUMPET

2018099

Ø2.5 / 2.0 mm
L= 300mm
HDPE
10 pcs



2018100

Ø2.5 / 2.0 mm
L= 1.000mm
HDPE
10 pcs



INNER LINER BRAKE

2018098

Ø2.5/2.0mm
L=1.000mm
HDPE Liner + ferrule
2 pcs

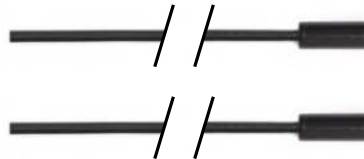

INNER LINER SHIFT

2018097

Ø2.0/1.4mm
L=750mm
HDPE Liner + ferrule
2 pcs



ANTI-RATTLE FOAM

2018015

Ø11.0/6.0mm
L=750mm
10 pcs in sealbag



Prevents rattling of internal cables and hoses.

SPIRAL WRAP TUBE

10 meter

2018031 Ø4mm bundles 3-8 mm
2018032 Ø6mm bundles 5-10 mm
2018033 Ø12mm bundles 9-65 mm
2018034 Ø15mm bundles 12-70 mm



BRAKE

DISC BRAKE SYSTEMS
CALIPER ADAPTERS
CALIPER BOLTS
DISC BRAKE ROTORS
DISC BRAKE PARTS
DISC BRAKE PADS
RIM BRAKE PADS

CABLE

INNER CABLES
OUTER CABLES
SUPERFLEX
CABLE KITS
CABLE PARTS

HYDRO

ORIGINAL BRANDS
HYDRO COMPONENTS
SHIMANO HYDRO COMPONENTS
O-RINGS

ROTATION

BEARINGS
HEADSET BEARINGS
HEADSET PARTS
PULLEY WHEELS
BOTTOM BRACKET GUIDE
BOTTOM BRACKETS
BOTTOM BRACKET PARTS

TOOLS AND MAINTENANCE

MAINTENANCE
CABLE TOOLS
HYDRO TOOLS
MORE TOOLS
BOTTOM BRACKET TOOLS

WORKSHOP

TRANSIT
BOXER
PARTNER
CADDY
PADFINDER
DISCOVERY

HYDRO





ORIGINAL BRAND HOSE EXTENSION SET

Extend original brand hydro hoses with fitting sets per brand.
Save a lot of time by avoiding internal cable guiding by easily extending your hose to the desired length.

ELV2020240

6 pcs extension nipples
12 pcs compression bolts
Fits any original hose
Use with compatible fittings



2019101

Shimano
SM-BH59 and SM-BH90



2019102

Magura



2019103

SRAM / Avid



2019104

Tektro



2019105

Formula



2019106

Hayes



BRAKE

- DISC BRAKE SYSTEMS
- CALIPER ADAPTERS
- CALIPER BOLTS
- DISC BRAKE ROTORS
- DISC BRAKE PARTS
- DISC BRAKE PADS
- RIM BRAKE PADS

CABLE

- INNER CABLES
- OUTER CABLES
- SUPERFLEX
- CABLE KITS
- CABLE PARTS

HYDRO

- ORIGINAL BRANDS
- HYDRO COMPONENTS
- SHIMANO HYDRO COMPONENTS
- O-RINGS

ROTATION

- BEARINGS
- HEADSET BEARINGS
- HEADSET PARTS
- PULLEY WHEELS
- BOTTOM BRACKET GUIDE
- BOTTOM BRACKETS
- BOTTOM BRACKET PARTS

TOOLS AND MAINTENANCE

- MAINTENANCE
- CABLE TOOLS
- HYDRO TOOLS
- MORE TOOLS
- BOTTOM BRACKET TOOLS

WORKSHOP

- TRANSIT
- BOXER
- PARTNER
- CADDY
- PADFINDER
- DISCOVERY

Learn more



ASSORTMENT BOX ORIGINAL BRAND HOSE FITTINGS

2015145

With this box, any original hose of Tektro, Shimano, Avid, SRAM, Hayes, Formula and Magura (except HS11/33) can be shortened. Contains parts to shorten 10 hoses per brand. 60 pieces in total.



ELV-AV01

Compression bolt

Avid
10 pcs



ELV-AV02-1

Olive

Avid
10 pcs



ELV-AV03-1

Insert

Avid
10 pcs



ELV-TK01

Compression bolt

Tektro
10 pcs



ELV-TK02

Olive

Tektro
10 pcs



ELV-TK03

Insert

Tektro
10 pcs



ELV-HY01

Compression bolt

Hayes
10 pcs



ELV-HY02

Insert with olive

Hayes
10 pcs



ELV-HY03

Olive

Hayes
10 pcs



ELV-SH01

Compression bolt

Shimano
10 pcs



ELV-SH02

Olive

Shimano
10 pcs



ELV-SH03

Insert SM-BH59

Shimano
10 pcs



ELV-SH04

Insert SM-BH90

Shimano
10 pcs



ELV-MG01

Compression bolt

Magura
10 pcs



ELV-MG02

Olive

Magura
10 pcs



ELV-MG03

Insert

Magura
10 pcs



ELV-MG04

Compression bolt M9

Magura
10 pcs



ELV-FM01

Compression bolt

Formula
10 pcs



ELV-FM02

Olive

Formula
10 pcs



ELV-FM03

Insert

Formula
10 pcs



ELV-FM04

Compression bolt

Formula
10 pcs



ELV-HP02

Olive

Hope
10 pcs



ELV-HP03

Insert

Hope
10 pcs



ELV-HP04

Washer (small)

Hope
10 pcs



ELV-HP05

Washer (large)

Hope
10 pcs



ORIGINAL BRAND HOSE FITTING SET

Shorten 2 original brand hydro hoses with fitting sets per brand. Packed in a sealbag.

CP2019130

Shimano
SM-BH59



CP2019131

Shimano
SM-BH90



CP2019132

Magura



CP2019133

SRAM / Avid



CP2019134

Tektro



CP2019135

Formula



CP2019136

Hayes



CP2020139

Elvedes



CP2021069

Hope



BRAKE

DISC BRAKE SYSTEMS
CALIPER ADAPTERS
CALIPER BOLTS
DISC BRAKE ROTORS
DISC BRAKE PARTS
DISC BRAKE PADS
RIM BRAKE PADS

CABLE

INNER CABLES
OUTER CABLES
SUPERFLEX
CABLE KITS
CABLE PARTS

HYDRO

ORIGINAL BRANDS
HYDRO COMPONENTS
SHIMANO HYDRO COMPONENTS
O-RINGS

ROTATION

BEARINGS
HEADSET BEARINGS
HEADSET PARTS
PULLEY WHEELS
BOTTOM BRACKET GUIDE
BOTTOM BRACKETS
BOTTOM BRACKET PARTS

TOOLS AND MAINTENANCE

MAINTENANCE
CABLE TOOLS
HYDRO TOOLS
MORE TOOLS
BOTTOM BRACKET TOOLS

WORKSHOP

TRANSIT
BOXER
PARTNER
CADDY
PADFINDER
DISCOVERY

HYDRO COMPONENTS

HYDRO HOSE VOLUME BOX

20 meters hose

Fits Elvedes parts only

Fits Boxer display (page 78)

2012030 Black

2012031 White



VOLUME BOX

Elvedes hydro hose is reinforced with a Kevlar housing and has a PTFE liner, which makes it suitable for both mineral oil and DOT fluid. The hydro hose volume boxes come with an easy pull reel made of 100% recycled and 100% recyclable plastic. The boxes are also equipped with a unique GripClip, which prevents the hose from slipping back into the box after cutting.

ASSORTMENT BOX HYDRO PARTS

2012096

Assortment box containing all hydraulic parts and accessories



ELV2017095

Compression bolt
M9 x 1.25
for Magura

Stainless steel

10 pcs



ELV2019115

Banjo bolt

Stainless steel

10 pcs



ELV2012097

Insert
for Elvedes Hydro
Hose only

Brass

30 pcs



ELV2012100

Connector M6

Stainless steel

10 pcs



ELV2012101

Banjo
for Elvedes Hydro
Hose only

Stainless steel

10 pcs



ELV2012104

Banjo bolt

Steel

10 pcs



ELV2012098

Olive

Brass

40 pcs



ELV2012099

Compression bolt
M8 x 0.75

Stainless steel

30 pcs



ELV2012103

Banjo bolt

Stainless steel

10 pcs



ELV2019116

Flange bolt M9
for Shimano

Steel

10 pcs



ELV2012102

Compression nut

Stainless steel

10 pcs



ELV2012105

Washer

Copper

30 pcs



HYDRO HOSE

3 meters hose.
For both front and rear brakes.
Suitable for mineral and DOT oil.
Fits Elvedes parts only

2011006	Black	
2011007	White	
2011008	Red	
2011009	Orange	
2011010	Blue	
2011011	Green	



HYDRO HOSE

Elvedes hydro hose is reinforced with a Kevlar housing and has a PTFE liner, which makes it suitable for both mineral oil and DOT fluid.

HYDRO PARTS KIT

Stainless Steel Parts.
For both front and rear brakes.
Fits Elvedes Hydro hose only

2011012	Kit 1 : M8 + M8
2011013	Kit 2 : M8 + Banjo
2011014	Kit 3 : Banjo + Banjo
2011015	Kit 4 : M8 + M6
2016025	Kit 5 : M8 + Banjo (Shimano)
2016009	Kit 6 : M8 X 1 + Banjo (New Form Mega/R/R1/R1R/Cura)
2016010	Kit 7 : M9 X 1.25 + Banjo (Mag. MT 4/5/5e/6/7/8)
2016011	Kit 8 : M9 X 1.25 + M6 (Mag. MT2)
2019122	Kit 9 : M9 Flange bolt + M8



FIT YOUR KIT

Avid/SRAM

Code, New Code, Juicy 3	Kit 1
All other Juicy, XX 2010-2011	Kit 2
Elixir, XO, XX 2012, Guide	Kit 4

Hayes

Sole, Dyno	Kit 1
All Stroker, all Prime, Trail, Carbon, Ace	Kit 2
Nine HFX-9	Kit 4

Magura

Gustav	Kit 2
Louise, Julie, Marta, New Marta	Kit 4
MT 4 / 5 / 5E / 6 / 7 / 8	Kit 7
MT 2, MT Sport	Kit 8

Elvedes

HP4000	Kit 1
--------	-------

Formula

RX, R1, The One, Mega	Kit 2
Oro	Kit 3
Mega, R, R1, R1R, Cura	Kit 6

Tektro

All Draco, Auriga Comp (WS)	Kit 1
Orion, Volans, all other Auriga	Kit 2

Shimano

MT200, M485, M486, M525, M535, M585, M595, M601, M665 M775, R785, M975	Kit 1
M755, M765, M776, RS785, M640, M800, M810, M988	Kit 2
M965, M966	Kit 3
M666, M675, M785, M985, M7000, M8000	Kit 5
ST-R9170, ST-R8070, ST-RX810, ST-R7070, ST-4770, ST-R400, ST-R9120, ST-R8020	Kit 9

BRAKE

- DISC BRAKE SYSTEMS
- CALIPER ADAPTERS
- CALIPER BOLTS
- DISC BRAKE ROTORS
- DISC BRAKE PARTS
- DISC BRAKE PADS
- RIM BRAKE PADS

CABLE

- INNER CABLES
- OUTER CABLES
- SUPERFLEX
- CABLE KITS
- CABLE PARTS

HYDRO

- ORIGINAL BRANDS
- HYDRO COMPONENTS
- SHIMANO HYDRO COMPONENTS
- O-RINGS

ROTATION

- BEARINGS
- HEADSET BEARINGS
- HEADSET PARTS
- PULLEY WHEELS
- BOTTOM BRACKET GUIDE
- BOTTOM BRACKETS
- BOTTOM BRACKET PARTS

TOOLS AND MAINTENANCE

- MAINTENANCE
- CABLE TOOLS
- HYDRO TOOLS
- MORE TOOLS
- BOTTOM BRACKET TOOLS

WORKSHOP

- TRANSIT
- BOXER
- PARTNER
- CADDY
- PADFINDER
- DISCOVERY

SHIMANO HYDRO COMPONENTS

REPLACING

2020106

With Kevlar and PTFE



L = 2000mm

2020107

With Kevlar and PTFE



L = 2000mm

2021082

Brake hose for Shimano SM-BH59
With Kevlar and PTFE
20 m



2020138

Brake hose for Shimano SM-BH90
With Kevlar and PTFE
20 m

REPLACING / SHORTENING

CP2019130

Fitting set SM-BH59



CP2019131

Fitting set SM-BH90



ELV-SH03

Insert SM-BH59
10 pcs



ELV-SH04

Insert SM-BH90
10 pcs



ELV-SH02

Olive
10 pcs



ELV-SH01

Compression bolt
10 pcs



EXTENDING

2019101

SM-BH59 and SM-BH90



L = 500mm



HOSE EXTENSION SET

Extend Shimano hydro hoses with the hose extension set. Save a lot of time by avoiding internal cable guiding by easily extending your hose to the desired length.

BLEEDING



How to bleed a Shimano brake system

Mineral oil red

compatible with Shimano SM-DB-OIL

2016005 100 ml
2015169 250 ml
2020238 1 000 ml



Mineral oil syringes

2018040
2 pcs



Bleed adapter set

2020095



Bleed nipple cap

2017186
10 pcs



ASSORTMENT BOX O-RINGS

2019240

Replacement o-rings for calipers and master cylinders.
Blue rings for mineral oil
Black rings for DOT oil

Contains 20 pieces of each o-ring



2019241

Shimano R785, XTR
M9000/9020, SLX M7000,
Deore XT M8000/8020,
Alfine S7000
20 pcs



2019242

Shimano Deore, XT, XTR
20 pcs



2019107

Magura MT4/5/6/7/8, Tektro
Orion (SL), Volans, Auriga
(SUB, Tune, Twin), Dorado,
Gemini SL
20 pcs



2019108

Magura MT4
20 pcs



2019109

SRAM Elixir 5, Guide
Ultimate, HydroR for
flatmount
20 pcs



2019110

SRAM Elixir 7/9, XO (Trail),
XX (World Cup), HydroR for
postmount
20 pcs



2019111

SRAM Elixir 7/9, XO (Trail),
XX (World Cup), HydroR for
postmount and Formula R1,
The One, Mega
20 pcs



2019112

SRAM Elixir 5 and Formula
The One
20 pcs



2019113

Formula RX
20 pcs



2019114

Hayes Prime, HFX-9, HFX-
MAG
20 pcs



BRAKE

DISC BRAKE SYSTEMS
CALIPER ADAPTERS
CALIPER BOLTS
DISC BRAKE ROTORS
DISC BRAKE PARTS
DISC BRAKE PADS
RIM BRAKE PADS

CABLE

INNER CABLES
OUTER CABLES
SUPERFLEX
CABLE KITS
CABLE PARTS

HYDRO

ORIGINAL BRANDS
HYDRO
COMPONENTS
SHIMANO HYDRO
COMPONENTS
O-RINGS

ROTATION

BEARINGS
HEADSET BEARINGS
HEADSET PARTS
PULLEY WHEELS
BOTTOM BRACKET
GUIDE
BOTTOM BRACKETS
BOTTOM BRACKET
PARTS

TOOLS AND MAINTENANCE

MAINTENANCE
CABLE TOOLS
HYDRO TOOLS
MORE TOOLS
BOTTOM BRACKET
TOOLS

WORKSHOP

TRANSIT
BOXER
PARTNER
CADDY
PADFINDER
DISCOVERY

ROTATION

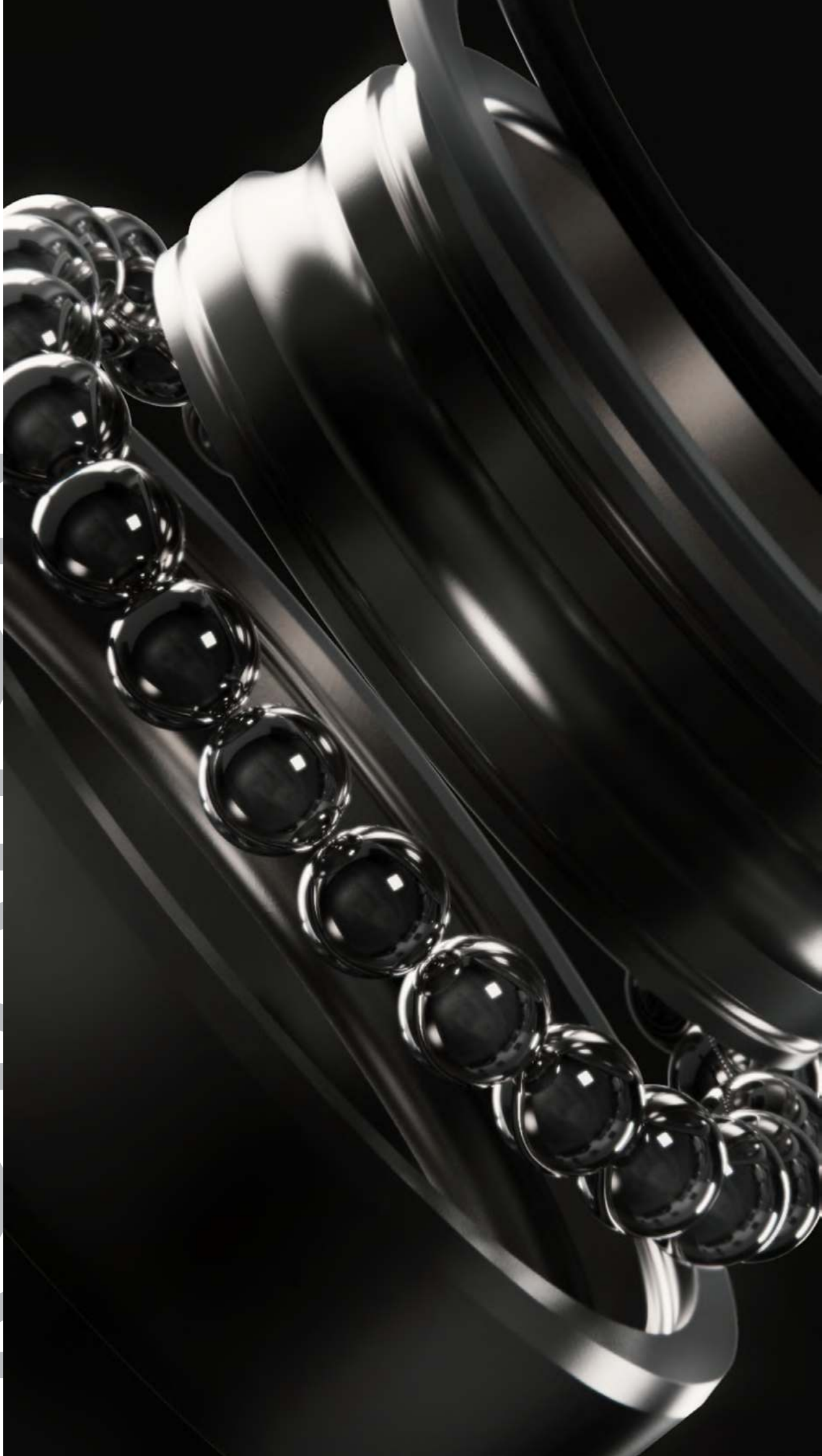



BEARINGS

All Elvedes bearings are produced complying to ABEC 3.
All Elvedes bearings are provided with extra grease for higher durability and performance.

INDUSTRIAL BEARING

- Balls separated by cage
- For full rotation parts
- ABEC 3



MAX BEARING

- Max amount of balls
- For minimum rotation parts
- For heavy loads
- ABEC 3



INDUSTRIAL STEEL BEARINGS

2017103	608 2RS	Ø22 × Ø8 × 7
2017104	609 2RS	Ø24 × Ø9 × 7
2017105	688 2RS	Ø16 × Ø8 × 5
2017106	699 2RS	Ø20 × Ø9 × 6
2017107	6000 2RS	Ø26 × Ø10 × 8
2017108	6001 2RS	Ø28 × Ø12 × 8
2017109	6800 2RS	Ø19 × Ø10 × 5
2017110	6801 2RS	Ø21 × Ø12 × 5
2017111	6802 2RS	Ø24 × Ø15 × 5
2017112	6803 2RS	Ø26 × Ø17 × 5
2017113	6804 2RS	Ø32 × Ø20 × 7
2017114	6805 2RS	Ø37 × Ø25 × 7
2017115	6806 2RS	Ø42 × Ø30 × 7
2017116	6900 2RS	Ø22 × Ø10 × 6
2017117	6901 2RS	Ø24 × Ø12 × 6
2017118	6902 2RS	Ø28 × Ø15 × 7
2017119	6903 2RS	Ø30 × Ø17 × 7
2017120	6904 2RS	Ø37 × Ø20 × 9
2017121	15267 2RS	Ø26 × Ø15 × 7
2020070	15268 2RS	Ø26 × Ø15 × 8
2017195	16100 2RS	Ø28 × Ø10 × 8
2017122	17287 2RS	Ø28 × Ø17 × 7
2018039	18307 2RS	Ø30 × Ø18 × 7
2017194	24377 2RS	Ø37 × Ø24 × 7
2021051	163110 2RS	Ø31 × Ø16 × 10

STEEL BEARING BALLS

2021075	1/8"	100 pcs/bag
2021076	5/32"	100 pcs/bag
2021077	3/16"	100 pcs/bag
2021078	1/4"	100 pcs/bag

MAX STEEL BEARINGS

2020052	606 2RS MAX	Ø17 × Ø6 × 6
2020053	608 2RS MAX	Ø22 × Ø8 × 7
2020054	688 2RS MAX	Ø16 × Ø8 × 5
2020055	698 2RS MAX	Ø19 × Ø8 × 6
2021018	3802 2RS MAX	Ø24 × Ø15 × 7
2021019	3803 2RS MAX	Ø26 × Ø17 × 7
2020066	3802W 2RS MAX	Ø24 × Ø15 × 10
2020067	3803W 2RS MAX	Ø26 × Ø17 × 10
2020056	6000 2RS MAX	Ø26 × Ø10 × 8
2020057	6001 2RS MAX	Ø28 × Ø12 × 8
2020058	6003 2RS MAX	Ø35 × Ø17 × 10
2020059	6800 2RS MAX	Ø19 × Ø10 × 5
2020060	6802 2RS MAX	Ø24 × Ø15 × 5
2021049	6803 2RS MAX	Ø26 × Ø17 × 5
2020061	6805 2RS MAX	Ø37 × Ø25 × 7
2021050	6806 2RS MAX	Ø42 × Ø30 × 7
2020062	6900 2RS MAX	Ø22 × Ø10 × 6
2020063	6901 2RS MAX	Ø24 × Ø12 × 6
2020064	6902 2RS MAX	Ø28 × Ø15 × 7
2020065	6903 2RS MAX	Ø30 × Ø17 × 7
2020069	10197 2RS MAX	Ø19 × Ø10 × 7
2020068	17286 2RS MAX	Ø28 × Ø17 × 6
2022026	15267 2RS MAX	Ø26 × Ø15 × 7



BRAKE

DISC BRAKE SYSTEMS
CALIPER ADAPTERS
CALIPER BOLTS
DISC BRAKE ROTORS
DISC BRAKE PARTS
DISC BRAKE PADS
RIM BRAKE PADS

CABLE

INNER CABLES
OUTER CABLES
SUPERFLEX
CABLE KITS
CABLE PARTS

HYDRO

ORIGINAL BRANDS
HYDRO COMPONENTS
SHIMANO HYDRO COMPONENTS
O-RINGS

ROTATION

BEARINGS
HEADSET BEARINGS
HEADSET PARTS
PULLEY WHEELS
BOTTOM BRACKET GUIDE
BOTTOM BRACKETS
BOTTOM BRACKET PARTS

TOOLS AND MAINTENANCE

MAINTENANCE
CABLE TOOLS
HYDRO TOOLS
MORE TOOLS
BOTTOM BRACKET TOOLS

WORKSHOP

TRANSIT
BOXER
PARTNER
CADDY
PADFINDER
DISCOVERY

BEARINGS

TYPE 688

Ø16 × Ø8 × 5
Industrial: **2017105**
MAX: **2020054**



TYPE 606

Ø17 × Ø6 × 6
Industrial: N/A
MAX: **2020052**



TYPE 698

Ø19 × Ø8 × 6
Industrial: N/A
MAX: **2020055**



TYPE 6800

Ø19 × Ø10 × 5
Industrial: **2017109**
MAX: **2020059**



TYPE 10197

Ø19 × Ø10 × 7
Industrial: N/A
MAX: **2020069**



TYPE 699

Ø20 × Ø9 × 6
Industrial: **2017106**
MAX: N/A



TYPE 6801

Ø21 × Ø12 × 5
Industrial: **2017110**
MAX: N/A



TYPE 608

Ø22 × Ø8 × 7
Industrial: **2017103**
MAX: **2020053**



TYPE 6900

Ø22 × Ø10 × 6
Industrial: **2017116**
MAX: **2020062**



TYPE 609

Ø24 × Ø9 × 7
Industrial: **2017104**
MAX: N/A



TYPE 6901

Ø24 × Ø12 × 6
Industrial: **2017117**
MAX: **2020063**



TYPE 6802

Ø24 × Ø15 × 5
Industrial: **2017111**
MAX: **2020060**



TYPE 3802

Ø24 × Ø15 × 7
Industrial: N/A
MAX: **2021018**



TYPE 3802

Ø24 × Ø15 × 10
Industrial: N/A
MAX: **2020066**



TYPE 6000

Ø26 × Ø10 × 8
Industrial: **2017107**
MAX: **2020056**



TYPE 15267

Ø26 × Ø15 × 7
Industrial: **2017121**
MAX: **2022026**

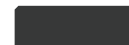

TYPE 15268

Ø26 × Ø15 × 8
Industrial: **2020070**
MAX: N/A



TYPE 6803

Ø26 × Ø17 × 5
Industrial: **2017112**
MAX: **2021049**



TYPE 3803

Ø26 × Ø17 × 7
Industrial: N/A
MAX: **2021019**



TYPE 3803w

Ø26 × Ø17 × 10
Industrial: N/A
MAX: **2020067**



TYPE 16100

Ø28 × Ø10 × 8
Industrial: **2017195**
MAX: N/A



TYPE 6001
Ø28 × Ø12 × 8
Industrial: **2017108**
MAX: **2020057**



TYPE 6902
Ø28 × Ø15 × 7
Industrial: **2017118**
MAX: **2020064**



TYPE 17286
Ø28 × Ø17 × 6
Industrial: N/A
MAX: **2020068**

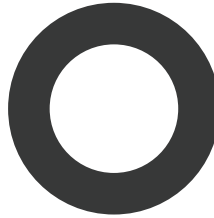

TYPE 17287
Ø28 × Ø17 × 7
Industrial: **2017122**
MAX: N/A

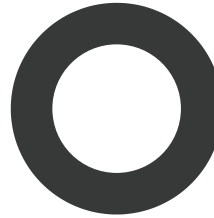

TYPE 6903
Ø30 × Ø17 × 7
Industrial: **2017119**
MAX: **2020065**



TYPE 18307
Ø30 × Ø18 × 7
Industrial: **2018039**
MAX: N/A

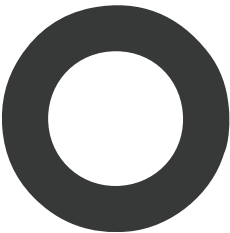

TYPE 163110
Ø31 × Ø16 × 10
Industrial: **2021051**
MAX: N/A



TYPE 6804
Ø32 × Ø20 × 7
Industrial: **2017113**
MAX: N/A



TYPE 6003
Ø35 × Ø17 × 10
Industrial: N/A
MAX: **2020058**



TYPE 6904
Ø37 × Ø20 × 9
Industrial: **2017120**
MAX: N/A



TYPE 24377
Ø37 × Ø24 × 7
Industrial: **2017194**
MAX: N/A

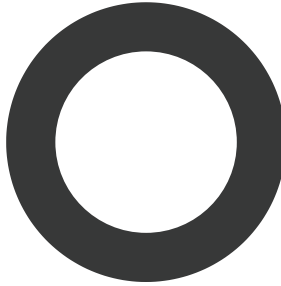

TYPE 6805
Ø37 × Ø25 × 7
Industrial: **2017114**
MAX: **2020061**

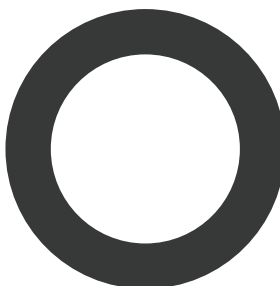

TYPE 6806
Ø42 × Ø30 × 7
Industrial: **2017115**
MAX: **2021050**

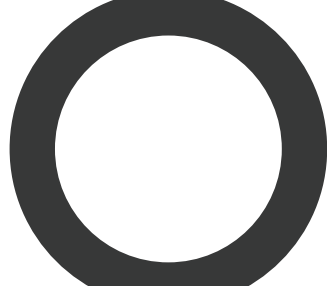

HEADSET BEARINGS

2017134

MR170
1½"
45° × 45°
Ø52 × Ø40 × 7



2017135

MR122
1½"
36° × 45°
Ø41 × Ø30,2 × 6,5



2017136

MR043
1½"
36° × 36°
Ø41,5 × Ø30,15 × 6,5



2017137

MR121
1½"
45° × 45°
Ø41,8 × Ø30,5 × 8



2017138

MR168
1¼"
45° × 45°
Ø46,8 × Ø34 × 7



2017139

MR151
1¾"
45° × 45°
Ø48,9 × Ø37 × 7



2017140

MR127
1½"
36° × 45°
Ø51,8 × Ø40 × 8



2017141

MR019
1½"
36° × 45°
Ø51,8 × Ø40 × 7,5



2017142

MR006
1½"
36° × 36°
Ø51 × Ø40 × 6,5



2017143

MR171
1½"
45° × 45°
Ø52 × Ø40 × 7,5



2017246

1¼"
45° × 45°
Ø46 × Ø34,1 × 7



2017247

1½"
36° × 45°
Ø41 × Ø30,15 × 7



2019049

MR155
1½"
45° × 45°
Ø41,8 × Ø30,9 × 7,5



2019050

MR137
1¼"
45° × 45°
Ø46,9 × Ø37 × 7



2019051

MR136
1½"
45° × 45°
Ø41 × Ø30,15 × 7



2019052

1¼"
45° × 45°
Ø41,8 × Ø32,8 × 6



2019053

1½"
36° × 45°
Ø41 × Ø30,15 × 7,7



2020048

1½"
45° × 45°
Ø41,8 × Ø30,2 × 6,5



2020049

1½"
45° × 45°
Ø52 × Ø40 × 6,5



2020050

1¾"
Ø44 × Ø35 × 5



2020051

1¾"
Ø48 × Ø37 × 7



2021124

1"
36° × 45°
Ø38 × Ø27,2 × 6,5



2021130

1½"
45° × 45°
Ø41 × Ø30,15 × 6,5



2022017

1¾"
36° × 45°
Ø48,9 × Ø37 × 6,5



2022033

1½"
45° × 45°
Ø52 × Ø42 × 7



2022034

1½"
36° × 45°
Ø52 × Ø40 × 6,5



2017144

Micro spacer for 1½"
Ø34,5 mm
0,25 mm



HEADSET BEARINGS

2019096

Assortment box high precision headset bearings

Contains 2 pcs of:

2017134	2017140	2019049
2017135	2017141	2019050
2017136	2017142	2019051
2017137	2017143	2019052
2017138	2017246	2019053
2017139	2017247	

Contains 10 pcs micro spacers
Refill per piece



HEADSET BEARINGS

TYPE MR168

1¼" Ø46,8 × Ø34 × 7 45° × 45°

2017138

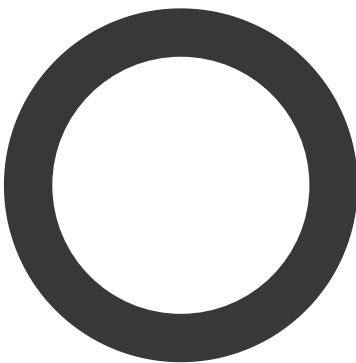

TYPE MR137

1¼" Ø46,9 × Ø37 × 7 45° × 45°

2019050

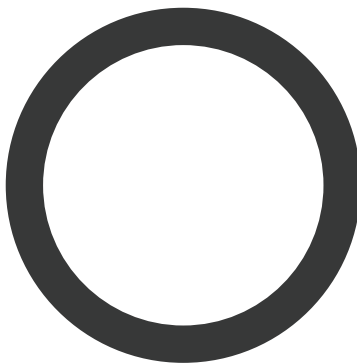

TYPE MR151

1½" Ø48,9 × Ø37 × 7 45° × 45°

2017139

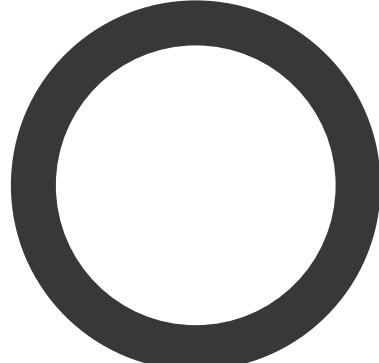

TYPE MR006

1½" Ø51 × Ø40 × 6,5 36° × 36°

2017142

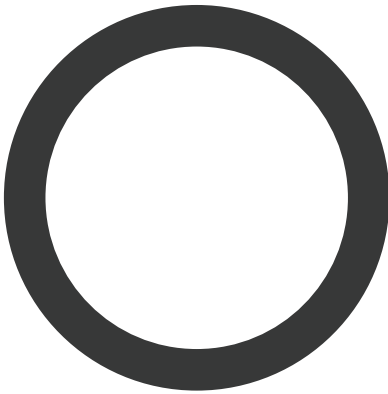

TYPE MR127

1½" Ø51,8 × Ø40 × 8 36° × 45°

2017140

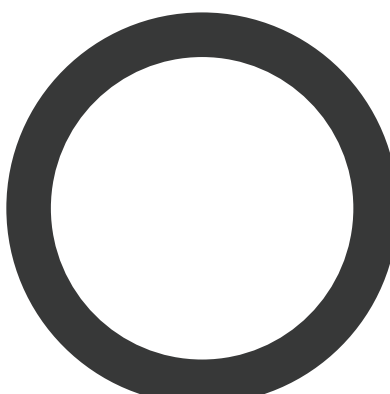

TYPE MR019

1½" Ø51,8 × Ø40 × 7,5 36° × 45°

2017141

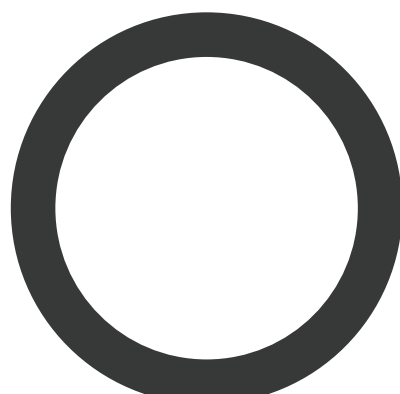

TYPE MR170

1½" Ø52 × Ø40 × 7 45° × 45°

2017134

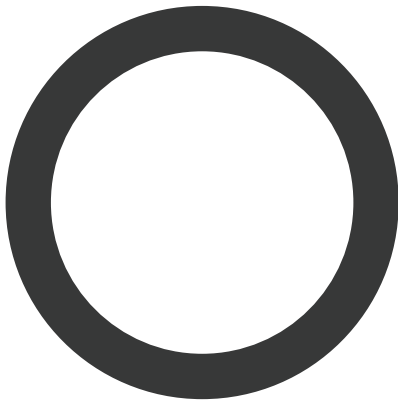

TYPE MR171

1½" Ø52 × Ø40 × 7,5 45° × 45°

2017143

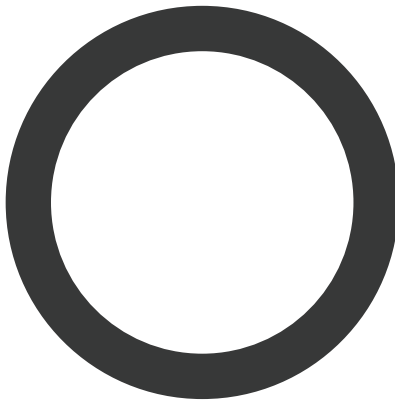

1½" Ø52 × Ø40 × 6,5 45° × 45°

2020049

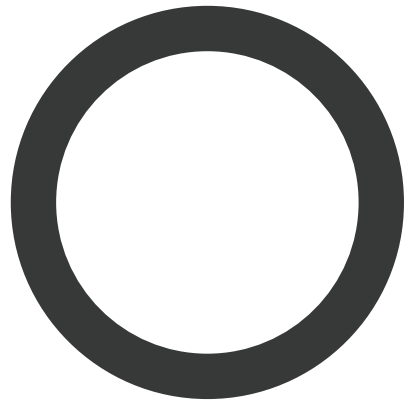

1½" Ø48,9 × Ø37 × 6,5 36° × 45°

2022017

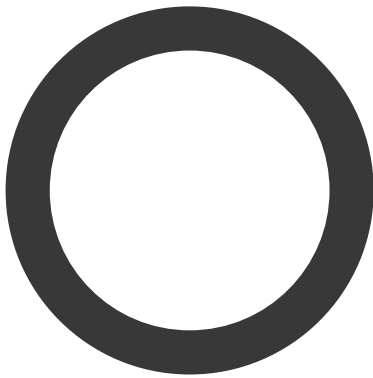

1½" Ø52 × Ø42 × 7 45° × 45°

2022033

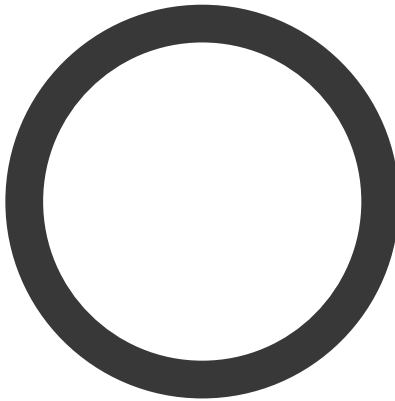

1½" Ø52 × Ø40 × 6,5 36° × 45°

2022034

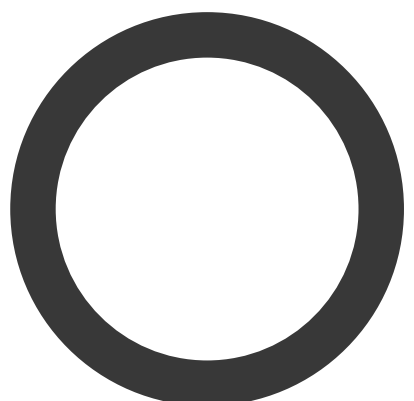

1½" Ø48 × Ø37 × 7

2020051

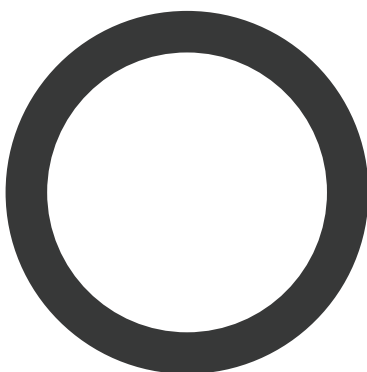

TYPE MR121

1¼" Ø41,8 × Ø30,5 × 8 45° × 45°

2017137

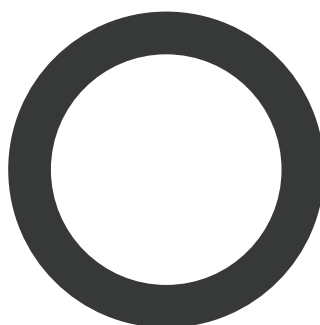

1½" Ø46 × Ø34,1 × 7 45° × 45°

2017246

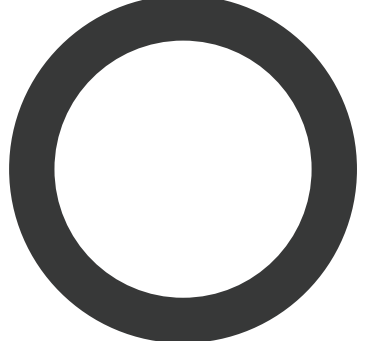

1 1/8" Ø41 x Ø30.15 x 7 36° x 45°
2017247

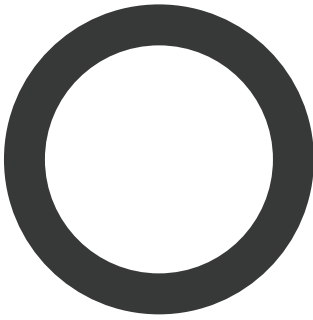

TYPE MR122
1 1/8" Ø41 x Ø30.2 x 6.5 36° x 45°
2017135

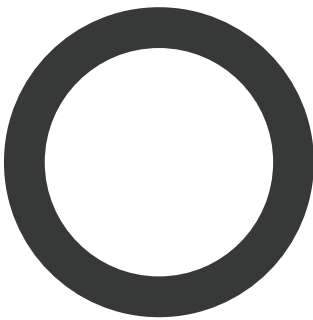

TYPE MR155
1 1/8" Ø41.8 x Ø30.9 x 7.5 45° x 45°
2019049

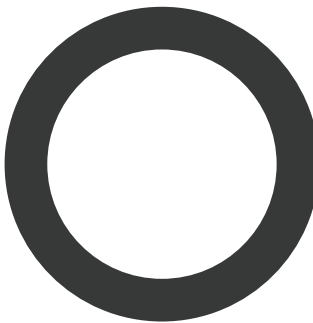

1 1/8" Ø41.8 x Ø30.2 x 6.5 45° x 45°
2020048

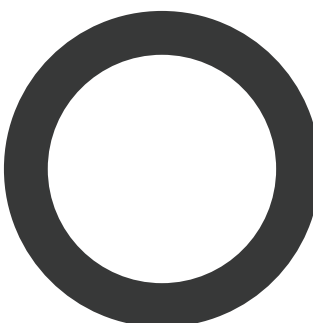

TYPE MR136
1 1/8" Ø41 x Ø30.15 x 7 45° x 45°
2019051

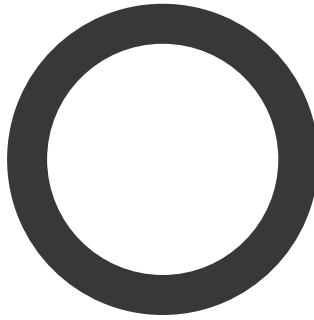

TYPE MR043
1 1/8" Ø41.5 x Ø30.15 x 6.5 36° x 36°
2017136

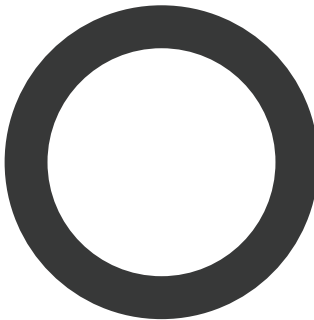

TYPE MR136
1 1/4" Ø41.8 x Ø32.8 x 6 45° x 45°
2019052

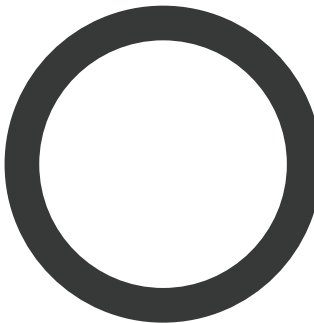

1 1/8" Ø44 x Ø35 x 5
2020050

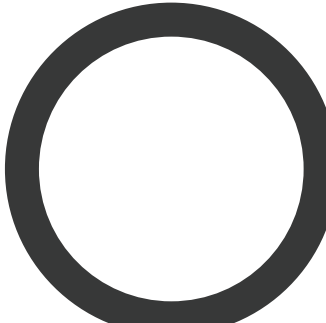

1 1/8" Ø41 x Ø30.15 x 7.7 36° x 45°
2019053

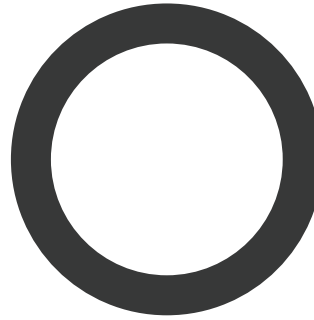

1 1/8" Ø41 x Ø30.15 x 6.5 45° x 45°
2021130

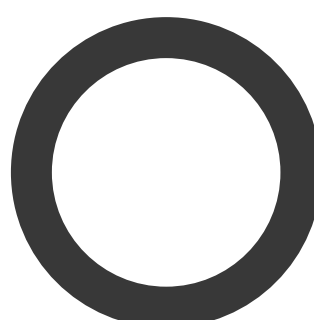

1" Ø38 x Ø27.2 x 6.5 36° x 45°
2021124

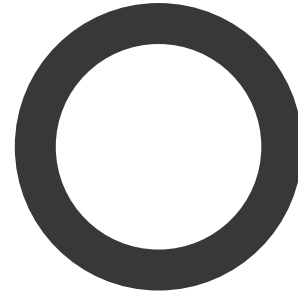

HEADSET PARTS

ASSORTMENT BOX HEADSET PARTS

2020140

Assortment box headset parts

Excludes 2022074 and 2022075



2022074

Fork cone for 1 1/8" to 1 1/2"

36° (silver)

Ø30 mm

1 pce



2022075

Fork cone for 1 1/8" to 1 1/2"

45° (black)

Ø30 mm

1 pce



2020129

Fork cone for 1 1/8"

36° (silver)

Ø30 mm

1 pce



2020130

Fork cone for 1 1/8"

45° (black)

Ø30 mm

1 pce



2020131

Fork cone for 1 1/4"

36° (silver)

Ø33 mm

1 pce



2020132

Fork cone for 1 1/4"

45° (black)

Ø33 mm

1 pce



2020133

Fork cone for 1 1/2"

36° (silver)

Ø39,8 mm

1 pce



2020134

Fork cone for 1 1/2"

45° (black)

Ø39,8 mm

1 pce



2020122

Top cover for 1 1/8"

Ø46 mm

8,2 mm

1 pce



2020123

Top cover for 1 1/8"

Ø50 mm

7,2 mm

1 pce



2020124

Top cover for 1 1/8"

Ø55 mm

7,2 mm

1 pce



2020125

Compression ring for 1 1/8"

36° (silver)

5,8 mm

1 pce



2020126

Compression ring for 1 1/8"

45° (black)

5,8 mm

1 pce



2020127

Compression ring for 1 1/8"

36° (silver)

8,4 mm

1 pce



2020128

Compression ring for 1 1/8"

45° (black)

8,4 mm

1 pce



2017144-10

Micro spacer for 1 1/8"

Ø34,5 mm

0,25 mm

10 pcs



2020136

Spacer for 1 1/8"

Ø34 mm

2 mm

5 pcs



2020117

Top cap assembly
sphere shape

For 1 1/8" metal tube

Incl. bolt, star nut
and rubber sealing cap

1 pce



2020118

Top cap assembly
flat shape

For 1 1/8" metal tube

Incl. bolt and star nut

1 pce



2020119

Compression device
23,5mm

For 1 1/8" carbon tube

Incl. bolt, top cap
and rubber
sealing cap

1 pce



2020120

Compression device
26mm

For 1 1/8" carbon tube

Incl. bolt and top cap

1 pce



2020121

Standard steel star nut

For 1 1/8" metal tube

5 pcs



2020135

Rubber sealing cap

For 5mm socket bolt

10 pcs





PULLEY WHEELS

All pulley wheel bearings are produced complying with ABEC 3 or ABEC 5
All pulley wheel bearings are provided with extra grease for higher durability and performance.

2 × 10 TEETH

CP2017231

ABEC 3 with extra grease
1 set
Stainless sealed bearing

Including spacers compatible with:
A - Shimano 8 speed
B - Shimano 7 speed, Campagnolo 8 speed
C - Campagnolo 9 / 10 speed
D - SRAM (one hole upper pulley) 9.0SL ('98) / 9.0 ('97 - '98) / 7.0 ('97 - '98) / 5.0 ('98 - '99)"



2 × 11 TEETH

CP2017086

1 set

2017086-BOX

10 sets

2017086-BOX25

25 sets

ABEC 3 with extra grease
Stainless sealed bearing

Including spacers compatible with:
A - Shimano 8 / 9 / 10 / 11 speed & 10 speed GRX
B - Shimano 7 speed, Campagnolo 8 speed
C - Campagnolo 9 / 10 speed
D - SRAM 7.0 / 9.0 ('97 - '99)"



11 + 13 TEETH

2022004

ABEC 5 with extra grease
1 set
Stainless sealed bearing

Compatible with:
Shimano 11 speed GRX
RD-RX810-GS
RD-RX812-GS
RD-RX815-GS
RD-RX817-GS



BRAKE

DISC BRAKE SYSTEMS
CALIPER ADAPTERS
CALIPER BOLTS
DISC BRAKE ROTORS
DISC BRAKE PARTS
DISC BRAKE PADS
RIM BRAKE PADS

CABLE

INNER CABLES
OUTER CABLES
SUPERFLEX
CABLE KITS
CABLE PARTS

HYDRO

ORIGINAL BRANDS
HYDRO COMPONENTS
SHIMANO HYDRO COMPONENTS
O-RINGS

ROTATION

BEARINGS
HEADSET BEARINGS
HEADSET PARTS
PULLEY WHEELS
BOTTOM BRACKET GUIDE
BOTTOM BRACKETS
BOTTOM BRACKET PARTS

TOOLS AND MAINTENANCE

MAINTENANCE
CABLE TOOLS
HYDRO TOOLS
MORE TOOLS
BOTTOM BRACKET TOOLS

WORKSHOP

TRANSIT
BOXER
PARTNER
CADDY
PADFINDER
DISCOVERY

PULLEY WHEELS

2 × 11 TEETH

CP2017100

ABEC 5 with extra grease
1 set
Stainless sealed bearing

Compatible with:
Shimano 9 / 10 / 11 speed & 10 speed GRX
SRAM X0 / X9 / X7 9 speed MTB > 2011
SRAM X0 / X9 / X7 10 speed MTB
SRAM Apex / Rival / Force 10 speed road
(bushing included)
Campagnolo 11 speed



2 × 13 TEETH

CP2019103

ABEC 5 with extra grease
1 set
Stainless sealed bearing

Compatible with:
Shimano RD-M9100 / M8100 / M7100



2 × 12 TEETH

CP2017101

ABEC 5 with extra grease
1 set
Narrow / wide
Stainless sealed bearing

Compatible with:
SRAM X01 / XX1 / X1 GX 1×11 speed
SRAM Rival 1 / Force 1 1×11 speed



12 + 14 TEETH

CP2017102

ABEC 5 with extra grease
1 set
Narrow / wide
Stainless sealed bearing

Compatible with:
SRAM Eagle XX1 / X01 / NX / SX / GX 1×12 speed
and 2×11 speed MTB



2 × 12 TEETH

2020097

ABEC 5 with extra grease
1 set
Narrow / wide
Ceramic hybrid bearing

Compatible with:
SRAM Force / Red eTap AXS



12 + 14 TEETH

2020098

ABEC 5 with extra grease
1 set
Narrow / wide
Ceramic hybrid bearing

Upgrade for:
SRAM Force / Red eTap AXS



BOTTOM BRACKET GUIDE —

GET STARTED

A bottom bracket shell can be threaded or non-threaded, called thread fit and press fit respectively. It is important to know which type of shell you're working with and what the shell diameter and width are, in order to select a fitting bottom bracket.

The most common thread types in thread fit shells are BSA (English thread), ITA (Italian thread) and T47 (M47×1). A thread type bottom bracket is interlocked directly with the shell. Press fit shells come in various diameters and widths, most commonly PF30 (Ø46mm), BB30 (Ø42mm) and BB86/92 (Ø41mm). Press fit bottom brackets are pressed into the shell using a press-in tool.

Another dimension you need to know in order to select a fitting bottom bracket is the spindle

diameter. Different brands and models can vary widely, from Ø30mm to tapered versions like Praxis (Ø30mm – Ø28mm). Differences between brands can also be as little as a few hundreds of millimeters.

Elvedes offers a basic range of bottom brackets, which can be easily adapted to specific types of spindles such as FSA Mega Exo and SRAM / Truvativ GXP using specific bearing caps or reducer kits.

Knowing all three dimensions, the guide on pages 62 – 64 can be used to select the perfectly fitting bottom bracket.

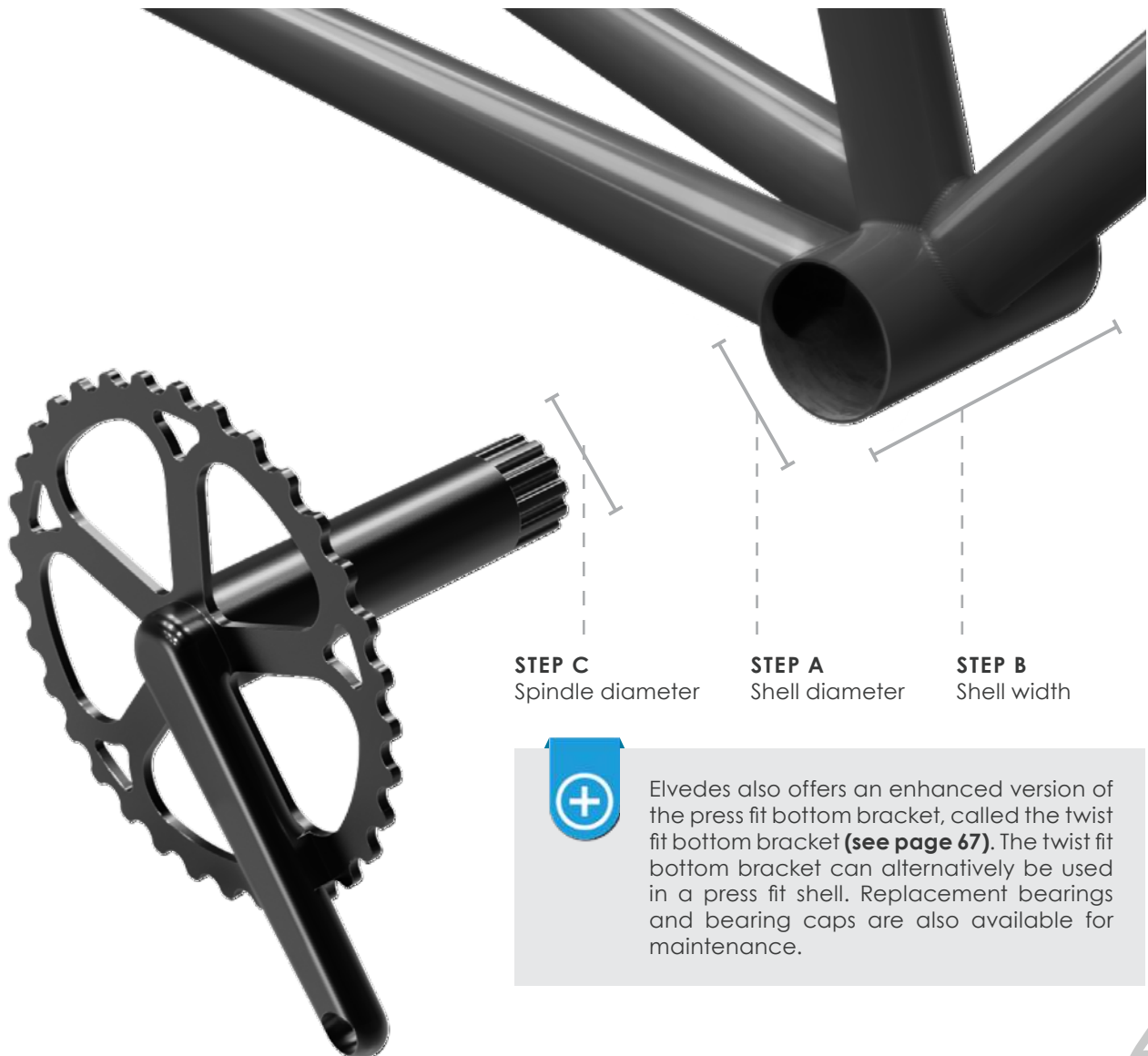

BOTTOM BRACKETS

SHIMANO HOLLOWTECH II

Go to:			Page 61			Page 65/67	Page 69	Page 75	Page 67	Page 69
			A	B	C	Item no.	Additionally required	Tool required	Replacement bearing	Replacement bearing cap
Thread fit	BSA	MTB	1,37" × 24 tpi	68 - 73 mm	24 mm	2018066		16T	2019087	2018081
		Road	1,37" × 24 tpi	68 mm	24 mm	2018065		16T	2019087	2018081
		Fatbike	1,37" × 24 tpi	100 mm	24 mm	2019085		16T	2019087	2018081
	ITA	Road	36 mm × 24 tpi	70 mm	24 mm	2018078		16T	2019087	2018081
	T47	External	M47 × 1	68 mm	24 mm	2020093		16T	2019087	2018081
		Internal	M47 × 1	86 mm	24 mm	2020092		16T	2019087	2018081
Press fit	BB86/92		41 mm	86 - 92 mm	24 mm	2018064			2019087	2018082
	BB386		46 mm	86 mm	24 mm	2021079			2019087	2019066
Twist fit	PF30		46 mm	68 - 73 mm	24 mm	2018073		16T	2019087	2018082
	BB30		42 mm							
	BB386		46 mm	86 mm	24 mm	2020084		16T	2019087	2018081
	BB86/92		41 mm	86 - 92 mm	24 mm	2018069		16T	2019087	2018082
		Fatbike	41 mm	106 - 132 mm	24 mm	2019084		16T	2019087	2018082
	BB right	Cervélo	46 mm	79 mm	24 mm	2021065		12T + 16T	2019087	2018082 + 2019066

SRAM / TRUVATIV GXP

Go to:			Page 61			Page 65/67	Page 69	Page 75	Page 67	Page 69
			A	B	C	Item no.	Additionally required	Tool required	Replacement bearing	Replacement bearing cap
Thread fit	BSA	MTB	1,37" × 24 tpi	68 - 73 mm	22 - 24 mm	2018067			2019087	
			1,37" × 24 tpi			2018066	2018080	16T	2019087	2018081
		Road	1,37" × 24 tpi	68 mm	22 - 24 mm	2018065	2018080	16T	2019087	2018081
		Fatbike	1,37" × 24 tpi	100 mm	24 mm	2019085	2018080	16T	2019087	2018081
	ITA	Road	36 mm × 24 tpi	70 mm	22 - 24 mm	2018078	2018080	16T	2019087	2018021
	T47	External	M47 × 1	68 mm	24 mm	2020093	2018080	16T	2019087	2018081
Internal		M47 × 1	86 mm	24 mm	2020092	2018080	16T	2019087	2018081	
Press fit	BB86/92		41 mm	86 - 92 mm	22 - 24 mm	2018064	2018080		2019087	2018082
	BB386		46 mm	86 mm	24 mm	2021079	2018080		2019087	2019066
Twist fit	PF30		46 mm	68 - 73 mm	22 - 24 mm	2018073	2018080	16T	2019087	2018082
	BB30		42 mm						2019087	
	BB386		46 mm	86 mm	22 - 24 mm	2020084	2018080	16T	2019087	2018082
	BB86/92		41 mm	86 - 92 mm	22 - 24 mm	2018069	2018080	16T	2019087	2018082
		Fatbike	41 mm	106-132mm	22 - 24 mm	2019084	2018080	16T	2019087	2018082
	BB right	Cervélo	46 mm	79 mm	24 mm	2021065	2018080	12T + 16T	2019087	2018082 + 2019066

SRAM DUB

Go to:			Page 61			Page 65/67	Page 69	Page 75	Page 67	Page 69
			A	B	C	Item no.	Additionally required	Tool required	Replacement bearing	Replacement bearing cap
Thread fit	BSA	MTB	1,37" × 24 tpi	68 - 73 mm	29 mm	2019118		12T	2018077	
	ITA	Road	36 mm × 24 tpi	70 mm	29 mm	2019119		12T	2018077	
	T47	External	M47 × 1	68 mm	29 mm	2020111		12T	2018077	
		Internal	M47 × 1	86 mm	29 mm	2020112		12T	2018077	
Press fit	BB86/92		41 mm	86 - 92 mm	29 mm	2019117				
Twist fit	PF30		46 mm	68 - 73 mm	29 mm	2019120		12T	2018077	
	BB30		42 mm							
	BB386		46 mm	86 mm	29 mm					

CAMPAGNOLO ULTRA-TORQUE

Go to:			Page 61			Page 65/67	Page 69	Page 75	Page 67	Page 69
			A	B	C	Item no.	Additionally required	Tool required	Replacement bearing	Replacement bearing cap
Twist fit	PF30		46 mm	68 mm	25 mm	2018074			2019086	
	BB386		46 mm	86 mm	25 mm	2020085			2019086	
	BB86		41 mm	86 mm	25 mm	2018070			2019086	

FSA MEGA EXO 24 MM

Go to:			Page 61			Page 65/67	Page 69	Page 75	Page 67	Page 69	
			A	B	C	Item no.	Additionally required	Tool required	Replacement bearing	Replacement bearing cap	
Thread fit	BSA	MTB	1,37" × 24 tpi	68 - 73 mm	24 mm	2018066	2018083	16T	2019087	2018083	
		Road	1,37" × 24 tpi	68 mm	24 mm	2018065	2018083	16T	2019087	2018083	
		Fatbike	1,37" × 24 tpi	100 mm	24 mm	2019085	2019067	16T	2019087	2019067	
	ITA	Road	36 mm × 24 tpi	70 mm	24 mm	2018078	2018083	16T	2019087	2018083	
	T47	External	M47 × 1	68 mm	24 mm	2020093	2018083	16T	2019087	2018083	
		Internal	M47 × 1	86 mm	24 mm	2020092	2018083	16T	2019087	2018083	
Press fit	BB86/92		41 mm	86 - 92 mm	24 mm	2018064	2018084		2019087	2018084	
	BB386		46 mm	86 mm	24 mm	2021079	2019067		2019087	2019067	
Twist fit	PF30		46 mm	68 - 73 mm	24 mm	2018073	2018083	16T	2019087	2018083	
	BB30		42 mm								
	BB386		46 mm	86 mm	24 mm						2020084
	BB86/92			41 mm	86 - 92 mm	24 mm	2018069	2018084	16T	2019087	2018084
		Fatbike		41 mm	106 - 132 mm	24 mm	2019084	2018084	16T	2019087	2018084
	BB right	Cervélo		46 mm	79 mm	24 mm	2021065	2019067 + 2019084	12T + 16T	2019087	2019067 + 2019084

BOTTOM BRACKETS

FSA MEGA EXO 19 MM

Go to:			Page 61			Page 65/67	Page 69	Page 75	Page 67	Page 69
			A	B	C	Item no.	Additionally required	Tool required	Replacement bearing	Replacement bearing cap
Thread fit	BSA	MTB	1,37" × 24 tpi	68 - 73 mm	19 mm	2018066	2019064	16T	2019087	2019064
		Road	1,37" × 24 tpi	68 mm	19 mm	2018065	2019064	16T	2019087	2019064
	ITA	Road	36 mm × 24 tpi	70 mm	19 mm	2018078	2019064	16T	2019087	2019064
	T47	External	M47 × 1	68 mm	19 mm	2020093	2019064	16T	2019087	2019064
		Internal	M47 × 1	86 mm	19 mm	2020092	2019064	16T	2019087	2019064
Press fit	BB86/92		41 mm	86 - 92 mm	19 mm	2018064	2019065		2019087	2019065
	BB386		46 mm	86 mm	19 mm	2021079	2019064		2019087	2019064
Twist fit	PF30		46 mm	68 - 73 mm	19 mm	2018073	2019064	16T	2019087	2019064
	BB30		42 mm							
	BB386		46 mm	86 mm	19 mm	2020084	2019065	16T	2019087	2019065
	BB86/92		41 mm	86 - 92 mm	19 mm	2018069	2019065	16T	2019087	2019065
		Fatbike	41 mm	106-132mm	19 mm	2019084	2019065	16T	2019087	2019065
	BB right	Cervélo	46 mm	79 mm	19 mm	2021065	2019064 + 2019065	12T + 16T	2019087	2019064 + 2019065

30 MM

Go to:			Page 61			Page 65/67	Page 69	Page 75	Page 67	Page 69
			A	B	C	Item no.	Additionally required	Tool required	Replacement bearing	Replacement bearing cap
Thread fit	BSA	Road	1,37" × 24 tpi	68 mm	30 mm	2018068		12T	2018077	
	ITA	Road	36 mm × 24 tpi	70 mm	30 mm	2018079		12T	2018077	
Press fit	PF30		46 mm	68 mm	30 mm	2019083			2018077	
	BB86/92		41 mm	86 - 92 mm	30 mm	2022085				
Twist fit	PF30	Fatbike	46 mm	100 mm	30 mm	2020086		12T	2018077	
			46 mm	68 - 92 mm	30 mm	2018071		12T	2018077	
	BB386/92							12T		

PRAXIS WORKS M30

Go to:			Page 61			Page 65/67	Page 69	Page 75	Page 67	Page 69
			A	B	C	Item no.	Additionally required	Tool required	Replacement bearing	Replacement bearing cap
Thread fit	BSA	Road	1,37" × 24 tpi	68 mm	28 - 30 mm	2020088		12T	2018077	
	ITA	Road	36 mm × 24 tpi	70 mm	28 - 30 mm	2020089		12T	2018077	
	T47		M47 × 1	68 mm	28 - 30 mm	2020115		12T	2018077	
			M47 × 1	86 mm	28 - 30 mm	2020114		12T	2018077	
Press fit	BB86/92		41 mm	86 - 92 mm	28 - 30 mm	2020087				
Twist fit	PF30		46 mm	68 mm	28 - 30 mm	2020090		12T	2018077	
	BB30		42 mm	68 mm	28 - 30 mm			12T		
	BB386		46 mm	86 mm	28 - 30 mm	2020091		12T	2018077	

THREAD FIT

Tool required: 2018086 Bottom bracket wrench

¹ Convertible to GXP with GXP reducer kit (2018080)

² Convertible to FSA with FSA bearing caps (page 69)

2018065
BSA Shimano Road ^{1 2}

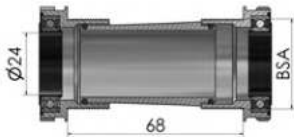

2018066
BSA Shimano MTB ^{1 2}

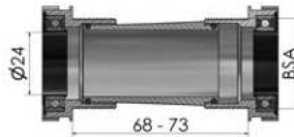

2018067
BSA GXP

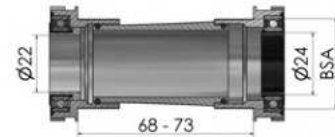

2018068
BSA IB30



2018078
ITA Shimano Road ^{1 2}

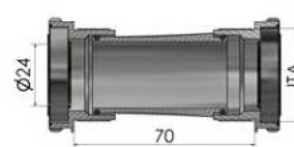

2018079
ITA IB30



2019118
BSA DUB

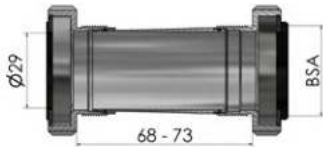

2019119
ITA DUB

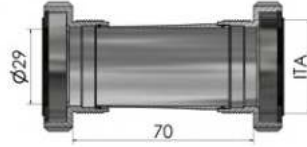

2019085
BSA Shimano Fatbike ^{1 2}

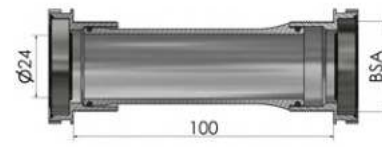

2020088
BSA Praxis

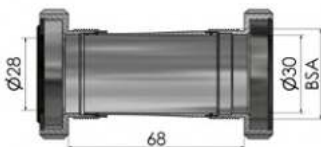

2020089
ITA Praxis



2020092
T47 Shimano Internal ^{1 2}



2020093
T47 Shimano External ^{1 2}

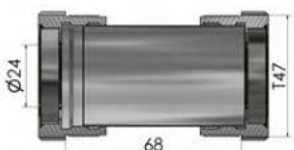

2020111
T47 DUB External

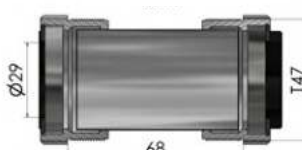

2020112
T47 DUB Internal

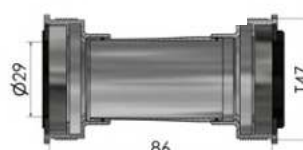

2020114
T47 Praxis Internal

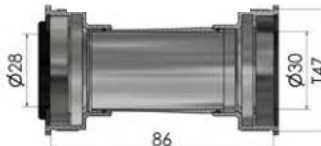

2020115
T47 Praxis External

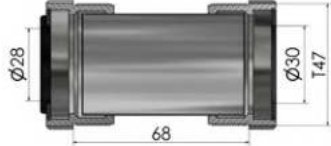

BRAKE

- DISC BRAKE SYSTEMS
- CALIPER ADAPTERS
- CALIPER BOLTS
- DISC BRAKE ROTORS
- DISC BRAKE PARTS
- DISC BRAKE PADS
- RIM BRAKE PADS

CABLE

- INNER CABLES
- OUTER CABLES
- SUPERFLEX
- CABLE KITS
- CABLE PARTS

HYDRO

- ORIGINAL BRANDS
- HYDRO COMPONENTS
- SHIMANO HYDRO COMPONENTS
- O-RINGS

ROTATION

- BEARINGS
- HEADSET BEARINGS
- HEADSET PARTS
- PULLEY WHEELS
- BOTTOM BRACKET GUIDE
- BOTTOM BRACKETS
- BOTTOM BRACKET PARTS

TOOLS AND MAINTENANCE

- MAINTENANCE
- CABLE TOOLS
- HYDRO TOOLS
- MORE TOOLS
- BOTTOM BRACKET TOOLS

WORKSHOP

- TRANSIT
- BOXER
- PARTNER
- CADDY
- PADFINDER
- DISCOVERY

BOTTOM BRACKETS

TWIST FIT

Tools required: 2018086 Bottom bracket wrench

¹ Convertible to GXP with GXP reducer kit (2018080)

² Convertible to FSA with FSA bearing caps (page 69)



LOW MAINTENANCE COSTS

Only the bearings can be replaced for service maintenance, while the bracket stays in place.



PERFECTLY IN LINE

The threaded interlocking cups allow the spindle to run freely without squeaking and creaking.



EASY INSTALLATION

Elvedes BB wrench required (item no. 2018086)

2018069
BB86/92 Shimano ^{1 2}

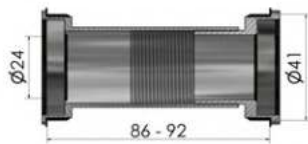

2018070
BB86 UT

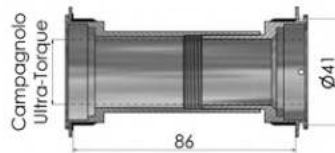

2018071
BB386/92
PF30



2018073
BB30 Shimano ^{1 2}
PF30 Shimano ^{1 2}

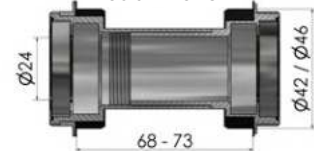

2018074
PF30 UT

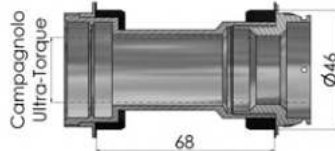

2019084
Shimano Fatbike ^{1 2}

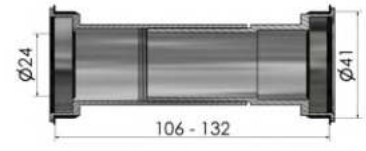

2019120
BB30 DUB
PF30 DUB

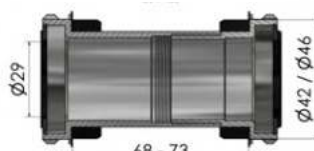

2019121
BB386 DUB

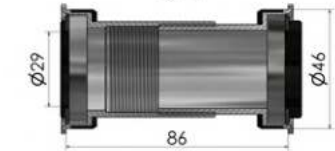

2020084
BB386 Shimano ^{1 2}

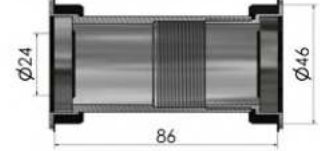

2020085
BB386 UT

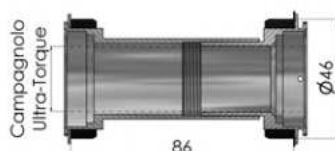

2020086
PF30 Fatbike



2020090
BB30 Praxis
PF30 Praxis

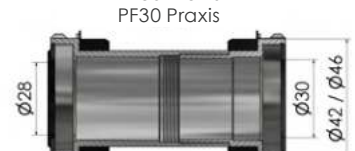

2020091
BB386 Praxis



2021065
BB right Shimano ^{1 2}



Scan the QR code for an online manual for (dis) assembling Elvedes twist fit bottom brackets using Twist fit tool kit.



PRESS FIT

- ¹ Convertible to GXP with GXP reducer kit (2018080)
- ² Convertible to FSA with FSA bearing caps (page 69)



BEARING REPLACEMENT KIT

- ¹ Includes bearing caps for Shimano and FSA
- ² Convertible to GXP with GXP reducer kit (2018080)



2019086
Campagnolo Ultra - Torque



2019087
All Elvedes 24mm BB systems ^{1 2}



BRAKE

- DISC BRAKE SYSTEMS
- CALIPER ADAPTERS
- CALIPER BOLTS
- DISC BRAKE ROTORS
- DISC BRAKE PARTS
- DISC BRAKE PADS
- RIM BRAKE PADS

CABLE

- INNER CABLES
- OUTER CABLES
- SUPERFLEX
- CABLE KITS
- CABLE PARTS

HYDRO

- ORIGINAL BRANDS
- HYDRO COMPONENTS
- SHIMANO HYDRO COMPONENTS
- O-RINGS

ROTATION

- BEARINGS
- HEADSET BEARINGS
- HEADSET PARTS
- PULLEY WHEELS
- BOTTOM BRACKET GUIDE
- BOTTOM BRACKETS
- BOTTOM BRACKET PARTS

TOOLS AND MAINTENANCE

- MAINTENANCE
- CABLE TOOLS
- HYDRO TOOLS
- MORE TOOLS
- BOTTOM BRACKET TOOLS

WORKSHOP

- TRANSIT
- BOXER
- PARTNER
- CADDY
- PADFINDER
- DISCOVERY

BOTTOM BRACKET PARTS

ASSORTMENT BOX BOTTOM BRACKET SPACERS

2019070

Contains 157 pcs

Excludes 2022006 and 2022007



2022006

Spacer ring

Plastic
 $\text{Ø}30 \times \text{Ø}24 \times 0,2 \text{ mm}$
 20 pcs



2022007

Spacer ring

Plastic
 $\text{Ø}36 \times \text{Ø}30 \times 0,2 \text{ mm}$
 20 pcs



2019071

Spacer ring

Plastic
 $\text{Ø}30 \times \text{Ø}24 \times 0,5 \text{ mm}$
 20 pcs



2019072

Spacer ring

Plastic
 $\text{Ø}30 \times \text{Ø}24 \times 1 \text{ mm}$
 20 pcs



2019073

Spacer ring

Plastic
 $\text{Ø}36 \times \text{Ø}30 \times 0,5 \text{ mm}$
 20 pcs



2019074

Spacer ring

Plastic
 $\text{Ø}36 \times \text{Ø}30 \times 1 \text{ mm}$
 20 pcs



2019075

Spacer ring

Aluminium
 $\text{Ø}38 \times \text{Ø}30 \times 2 \text{ mm}$
 6 pcs



2019076

Spacer ring

Aluminium
 $\text{Ø}38 \times \text{Ø}30 \times 5 \text{ mm}$
 4 pcs



2019077

Spacer ring

Aluminium
 $\text{Ø}38 \times \text{Ø}30 \times 7 \text{ mm}$
 3 pcs



2019078

Spacer ring

Aluminium
 $\text{Ø}38 \times \text{Ø}30 \times 9 \text{ mm}$
 2 pcs



2019079

Spacer ring

Aluminium
 $\text{Ø}38 \times \text{Ø}30 \times 11 \text{ mm}$
 2 pcs



2019080

Wave washer

Aluminium
 $\text{Ø}31 \times \text{Ø}22 \times 0,3 \text{ mm}$
 20 pcs



2019081

Wave washer

Aluminium
 $\text{Ø}31 \times \text{Ø}24 \times 0,6 \text{ mm}$
 20 pcs



2019082

Wave washer

Aluminium
 $\text{Ø}40,5 \times \text{Ø}32,8 \times 0,3 \text{ mm}$
 20 pcs



ASSORTMENT BOX BOTTOM BRACKET BEARING CAPS

2019056

2 pcs of every bearing cap
1 set GXP adapter



Scan code to discover
all bearing caps



2018081

40 mm with edge

Shimano
Type A
2 pcs



2018082

37 mm without edge

Shimano
Type B
2 pcs



2018083

40 mm with edge

FSA
Type C
2 pcs



2018084

37 mm without edge

FSA
Type D
2 pcs



2019064

40 mm without edge

FSA 19 mm Mega Exo
Type E
2 pcs



2019065

37 mm without edge

FSA 19 mm Mega Exo
Type F
2 pcs



2019066

40 mm without edge

Shimano (fits Trek)
Type A0
2 pcs



2019067

40 mm without edge

FSA (fits Trek)
Type C0
2 pcs



2018080

GXP reducer kit
24 mm to 22 mm



How to apply the
GXP reducer kit



BRAKE

DISC BRAKE SYSTEMS
CALIPER ADAPTERS
CALIPER BOLTS
DISC BRAKE ROTORS
DISC BRAKE PARTS
DISC BRAKE PADS
RIM BRAKE PADS

CABLE

INNER CABLES
OUTER CABLES
SUPERFLEX
CABLE KITS
CABLE PARTS

HYDRO

ORIGINAL BRANDS
HYDRO COMPONENTS
SHIMANO HYDRO COMPONENTS
O-RINGS

ROTATION

BEARINGS
HEADSET BEARINGS
HEADSET PARTS
PULLEY WHEELS
BOTTOM BRACKET GUIDE
BOTTOM BRACKETS
BOTTOM BRACKET PARTS

TOOLS AND MAINTENANCE

MAINTENANCE
CABLE TOOLS
HYDRO TOOLS
MORE TOOLS
BOTTOM BRACKET TOOLS

WORKSHOP

TRANSIT
BOXER
PARTNER
CADDY
PADFINDER
DISCOVERY

TOOLS AND MAINTENANCE

ETHANOL CLEANER

2018037
40/60
500 ml



ETHANOL CLEANER REFILL

2018089
40/60
500 ml



DISC CLEANER

2016020
500 ml



GREASE GUN

2019035
Labels included
Grease not included
80 ml



How to (re)fill

ORIGINAL NOZZLE

2020113
Short
Spare part
For grease gun



EXTENSION NOZZLE

2019036
Long
100mm
For grease gun



ASSEMBLY PASTE

2020212
Refill for grease gun
White
Not for carbon parts
110g



ROLLERBRAKE GREASE

2019038
Refill for grease gun
Black
110 g



LITHIUM GREASE

2019037
Refill for grease gun
Blue
110g



MINERAL OIL BLUE

for all mineral systems
colour based on Magura
Royal Blood

2016006 100 ml
2015170 250 ml
2020239 1 000 ml



MINERAL OIL RED

for all mineral systems

colour based on Shima-
no SM-DB-OIL

2016005 100 ml
2015169 250 ml
2020238 1 000 ml



DOT OIL

for all DOT systems

2015171 100 ml



CABLE PRICKER

2012029

Fits Ø4,1 and Ø4,9 mm outer cable

SPARE NEEDLE

2012029-1

for cable pricker
incl. fixing bolt



DEVELOPED BY **ELVEDES**



BRAKE

- DISC BRAKE SYSTEMS
- CALIPER ADAPTERS
- CALIPER BOLTS
- DISC BRAKE ROTORS
- DISC BRAKE PARTS
- DISC BRAKE PADS
- RIM BRAKE PADS

CABLE

- INNER CABLES
- OUTER CABLES
- SUPERFLEX
- CABLE KITS
- CABLE PARTS

HYDRO

- ORIGINAL BRANDS
- HYDRO COMPONENTS
- SHIMANO HYDRO COMPONENTS
- O-RINGS

CABLE CUTTER BASIC

2017070



CABLE CUTTER PROFESSIONAL

2009018
Felco C7

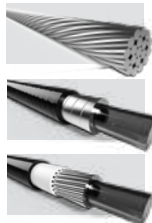

ROTATION

- BEARINGS
- HEADSET BEARINGS
- HEADSET PARTS
- PULLEY WHEELS
- BOTTOM BRACKET GUIDE
- BOTTOM BRACKETS
- BOTTOM BRACKET PARTS

END CAP CRIMPING TOOL

2016093

For shift and brake end caps



FERRULE CRIMPING TOOL

2009019



TOOLS AND MAINTENANCE

- MAINTENANCE
- CABLE TOOLS
- HYDRO TOOLS
- MORE TOOLS
- BOTTOM BRACKET TOOLS

WORKSHOP

- TRANSIT
- BOXER
- PARTNER
- CADDY
- PADFINDER
- DISCOVERY

HOSE PRICKER

2022051

For Ø5,0 and Ø5,5 mm hydraulic hose



SPARE NEEDLE

2022051-1

for hose pricker
incl. fixing bolt



BLEEDING KIT

2012095

For mineral and DOT oil.
Incl. adapters for Shimano, Magura, Hayes,
Avid / SRAM, Formula, Tektro and Elvedes



How to bleed a
Shimano brake
system



BLEED ADAPTER SET

2020095
Shimano



2020224
SRAM /
Avid



2018043
Magura



2018047
Hayes



2018044
Tektro



2018048
Elvedes
HP4000



2018045
Formula



2022045
Promax



BLEED BLOCK

2022080

Universal bleed
block

1 pce

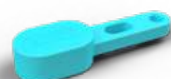

OIL SYRINGES

2018040

Mineral oil syringes

2 pcs

2018041

DOT oil syringes

2 pcs



OPEN RING WRENCH 7 / 8

2017056

Specially designed for Shimano bleed bolt (7 mm)
For easy access to compression bolts (8 mm)



CROWS FOOT SPANNER 8MM

2020094

For compression bolts (8 mm)

Fits 1/4" torque wrench



BRAKE

DISC BRAKE SYSTEMS
CALIPER ADAPTERS
CALIPER BOLTS
DISC BRAKE ROTORS
DISC BRAKE PARTS
DISC BRAKE PADS
RIM BRAKE PADS

HOSE CUTTER BASIC

2019042

For smooth and burr-free cutted hydraulic hose
Prevents leakage and damage of the hose

For consumer use

Spare blade included inside



CABLE

INNER CABLES
OUTER CABLES
SUPERFLEX
CABLE KITS
CABLE PARTS

END PRESS

2017159

For fast and easily pressing inserts and banjos into hydraulic hose

Not suitable for Magura HS11/33



HYDRO

ORIGINAL BRANDS
HYDRO COMPONENTS
SHIMANO HYDRO COMPONENTS
O-RINGS

ROTATION

BEARINGS
HEADSET BEARINGS
HEADSET PARTS
PULLEY WHEELS
BOTTOM BRACKET GUIDE
BOTTOM BRACKETS
BOTTOM BRACKET PARTS

HOSE CUTTER PROFESSIONAL

2019124

For smooth and burr-free cutted hydraulic hose
Prevents leakage and damage of the hose



TOOLS AND MAINTENANCE

MAINTENANCE
CABLE TOOLS
HYDRO TOOLS
MORE TOOLS
BOTTOM BRACKET TOOLS

SPARE INSERT DRIVER

2018112

For End press 2017159



SPARE BLADE

2019232

For Hose cutter 2019124



WORKSHOP

TRANSIT
BOXER
PARTNER
CADDY
PADFINDER
DISCOVERY

INTERNAL CABLE GUIDE

2018057

Accessories included
For more liners see page 41



How to use the
internal cable guide



ACCESSORIES REPLACEMENT SET

2019270

For internal cable guide 2018057

Magnetic pull wire



Pull wire



Magnet connector



Di2 connector



Cable and hose connector



Inner cable connector



2-WAY CONNECTOR

2022068

For connecting outer cables and
hoses end-to-end



MECHANIC HEADLAMP

2019040

For perfect visibility during
internal cable guiding
and frame inspection

Beam adjustment
function

Batteries (4× AAA)
not included



PICK-UP MAGNET TOOL

2020096

For easily picking up internal
cables, steel bearing
balls and more

40 mm



O-RING / SEAL REMOVAL TOOL SET

2020202

Specially designed for easily
removing and replacing o-rings
and bearing seals



INNER WIRE TENSION TOOL

2019041

For shift and brake inner wires



MULTI TOOL

2018026

Multi tool for disc brake and Centra-lock rings



Discover all features



DISC ALIGNMENT TOOL

2019043



TWIST FIT TOOL KIT

2018087

Tool kit to (dis)assemble all Elvedes twist fit, thread fit and SRAM DUB bottom brackets.

16T Hollowtech II - 42,5mm
12T SRAM DUB - 44mm
12T Elvedes - 48,5mm



How to use the Twist fit tool kit



BEARING SERVICE KIT

2018088

Tool kit to (dis)assemble bottom bracket bearings



How to use the Bearing service kit



BOTTOM BRACKET WRENCH

2018086

Bottom bracket wrench for all Elvedes twist fit and thread fit systems

16T Hollowtech II - 42,5mm
12T Elvedes - 48,5mm



SRAM DUB TOOL ADAPTER

2019069

For Elvedes Twist fit and thread fit and original SRAM DUB

12T SRAM DUB - 44mm
12T Elvedes - 48,5mm

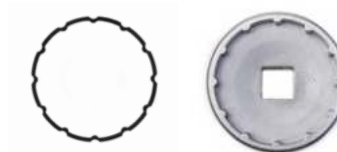

BRAKE

- DISC BRAKE SYSTEMS
- CALIPER ADAPTERS
- CALIPER BOLTS
- DISC BRAKE ROTORS
- DISC BRAKE PARTS
- DISC BRAKE PADS
- RIM BRAKE PADS

CABLE

- INNER CABLES
- OUTER CABLES
- SUPERFLEX
- CABLE KITS
- CABLE PARTS

HYDRO

- ORIGINAL BRANDS
- HYDRO COMPONENTS
- SHIMANO HYDRO COMPONENTS
- O-RINGS

ROTATION

- BEARINGS
- HEADSET BEARINGS
- HEADSET PARTS
- PULLEY WHEELS
- BOTTOM BRACKET GUIDE
- BOTTOM BRACKETS
- BOTTOM BRACKET PARTS

TOOLS AND MAINTENANCE

- MAINTENANCE
- CABLE TOOLS
- HYDRO TOOLS
- MORE TOOLS
- BOTTOM BRACKET TOOLS

WORKSHOP

- TRANSIT
- BOXER
- PARTNER
- CADDY
- PADFINDER
- DISCOVERY

WORKSHOP



TRANSIT

2016042

No displays included

Dimensions
97x180x41 cm

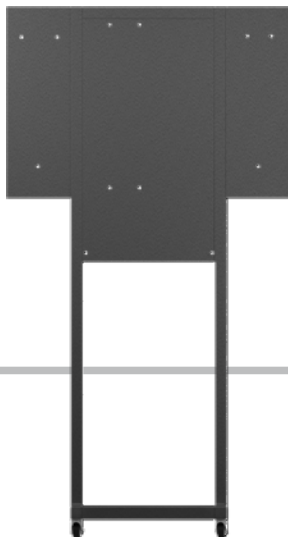

In order to increase efficiency in the workshop, Elvedes has developed a compact all-in-one mobile frame. This facilitates you to quickly and easily find all components you need for replacing cables and brake parts. No displays included. See page 78 - 83

5 full displays = Transit for free

BRAKE

- DISC BRAKE SYSTEMS
- CALIPER ADAPTERS
- CALIPER BOLTS
- DISC BRAKE ROTORS
- DISC BRAKE PARTS
- DISC BRAKE PADS
- RIM BRAKE PADS

CABLE

- INNER CABLES
- OUTER CABLES
- SUPERFLEX
- CABLE KITS
- CABLE PARTS

HYDRO

- ORIGINAL BRANDS
- HYDRO COMPONENTS
- SHIMANO HYDRO COMPONENTS
- O-RINGS

ROTATION

- BEARINGS
- HEADSET BEARINGS
- HEADSET PARTS
- PULLEY WHEELS
- BOTTOM BRACKET GUIDE
- BOTTOM BRACKETS
- BOTTOM BRACKET PARTS

TOOLS AND MAINTENANCE

- MAINTENANCE
- CABLE TOOLS
- HYDRO TOOLS
- MORE TOOLS
- BOTTOM BRACKET TOOLS

WORKSHOP

- TRANSIT
- BOXER
- PARTNER
- CADDY
- PADFINDER
- DISCOVERY

BOXER

BOXER

2017027

Dimensions

53 x 36 x 36 cm
Fasteners included



Free choice of cable types!

3 volume boxes stainless inner cable
4 volume boxes outer cable
See page 27 + 30

Full display = display for free



PARTNER

2018115

Dimensions
53 x 14 x 7cm

Smart fix system



BRAKE

- DISC BRAKE SYSTEMS
- CALIPER ADAPTERS
- CALIPER BOLTS
- DISC BRAKE ROTORS
- DISC BRAKE PARTS
- DISC BRAKE PADS
- RIM BRAKE PADS

CABLE

- INNER CABLES
- OUTER CABLES
- SUPERFLEX
- CABLE KITS
- CABLE PARTS

HYDRO

- ORIGINAL BRANDS
- HYDRO COMPONENTS
- SHIMANO HYDRO COMPONENTS
- O-RINGS

ROTATION

- BEARINGS
- HEADSET BEARINGS
- HEADSET PARTS
- PULLEY WHEELS
- BOTTOM BRACKET GUIDE
- BOTTOM BRACKETS
- BOTTOM BRACKET PARTS

TOOLS AND MAINTENANCE

- MAINTENANCE
- CABLE TOOLS
- HYDRO TOOLS
- MORE TOOLS
- BOTTOM BRACKET TOOLS

WORKSHOP

- TRANSIT
- BOXER
- PARTNER
- CADDY
- PADFINDER
- DISCOVERY

Free choice of cable parts!

10 jars
See page 36 - 40

Full display = display for free



CADDY

2017091

Dimensions
19,5 x 65 x 12,5 cm

Fasteners included



Free choice of rim brake pads!

Choose 3 boxes with
25 pairs rim brake pads

See page 23-25

Full display = display for free

PADFINDER

2017024

Dimensions
13 x 65 x 12,5 cm

Fasteners included



BRAKE

- DISC BRAKE SYSTEMS
- CALIPER ADAPTERS
- CALIPER BOLTS
- DISC BRAKE ROTORS
- DISC BRAKE PARTS
- DISC BRAKE PADS
- RIM BRAKE PADS

CABLE

- INNER CABLES
- OUTER CABLES
- SUPERFLEX
- CABLE KITS
- CABLE PARTS

HYDRO

- ORIGINAL BRANDS
- HYDRO COMPONENTS
- SHIMANO HYDRO COMPONENTS
- O-RINGS

ROTATION

- BEARINGS
- HEADSET BEARINGS
- HEADSET PARTS
- PULLEY WHEELS
- BOTTOM BRACKET GUIDE
- BOTTOM BRACKETS
- BOTTOM BRACKET PARTS

TOOLS AND MAINTENANCE

- MAINTENANCE
- CABLE TOOLS
- HYDRO TOOLS
- MORE TOOLS
- BOTTOM BRACKET TOOLS

WORKSHOP

- TRANSIT
- BOXER
- PARTNER
- CADDY
- PADFINDER
- DISCOVERY



Free choice of disc brake pads!

Choose 4 boxes with
10 pairs disc brake pads

See page 17-21

Full display = display for free

DISCOVERY STARTER KIT

2020045

1 pair of each disc brake pad in organic compound

The Discovery can be used in 3 different settings:

1. Swing display (use additional arm)
2. Wall display
3. Counter display (use additional bottom base)

Necessary parts and fasteners included

Dimensions
38 x 65,5 x 15 cm

POSTER

2022099

Included with each Discovery
Separately available

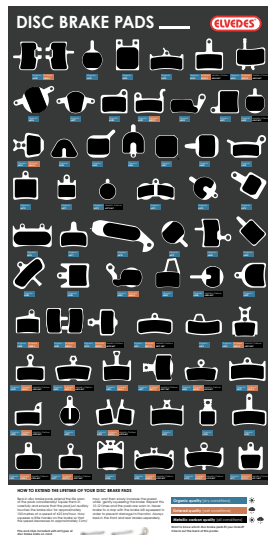

1 pair of each disc brake pad in organic compound

See page 17-21

Full display = display for free

DISCOVERY

2016074

The Discovery can be used in 3 different settings:

1. Swing display (use additional arm)
2. Wall display
3. Counter display (use additional bottom base)

Necessary parts and fasteners included

Dimensions
38 x 65,5 x 15 cm

POSTER

2022099

Included with each Discovery
Separately available

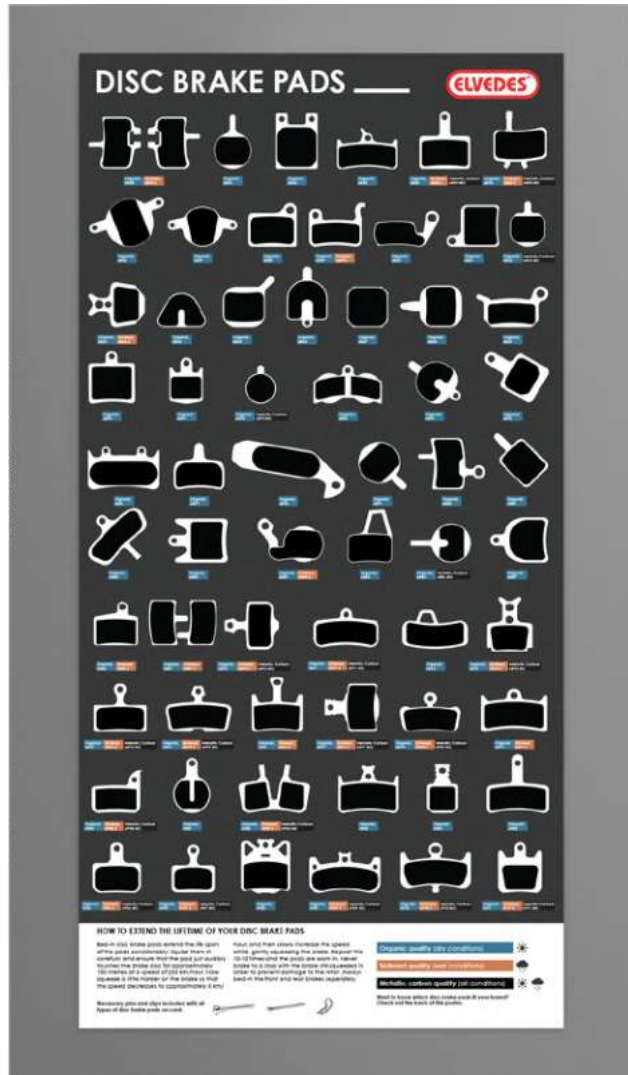
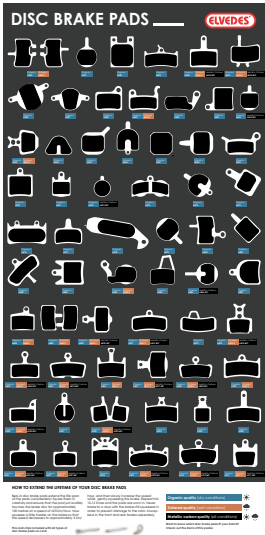

BRAKE

- DISC BRAKE SYSTEMS
- CALIPER ADAPTERS
- CALIPER BOLTS
- DISC BRAKE ROTORS
- DISC BRAKE PARTS
- DISC BRAKE PADS
- RIM BRAKE PADS

CABLE

- INNER CABLES
- OUTER CABLES
- SUPERFLEX
- CABLE KITS
- CABLE PARTS

HYDRO

- ORIGINAL BRANDS
- HYDRO COMPONENTS
- SHIMANO HYDRO COMPONENTS
- O-RINGS

ROTATION

- BEARINGS
- HEADSET BEARINGS
- HEADSET PARTS
- PULLEY WHEELS
- BOTTOM BRACKET GUIDE
- BOTTOM BRACKETS
- BOTTOM BRACKET PARTS

TOOLS AND MAINTENANCE

- MAINTENANCE
- CABLE TOOLS
- HYDRO TOOLS
- MORE TOOLS
- BOTTOM BRACKET TOOLS

WORKSHOP

- TRANSIT
- BOXER
- PARTNER
- CADDY
- PADFINDER
- DISCOVERY

Free choice of disc brake pads!

Choose 100 pairs disc brake pads to fill the Discovery

See page 17-21

Full display = display for free





Bike components.



**Elvedes
Youtube
Channel**
scan QR

Elvedes.com

info@elvedes.com
+31 (0)416 374 597

Visiting address

Grutter 7
NL-5253 RM Nieuwkuijk
The Netherlands

Item no. 2022098

